

Pioneer

ELITE

AUDIO/VIDEO
MULTI-CHANNEL RECEIVER

VSX-39TX

Operating Instructions

Thank you for buying this Pioneer product. Please read through these operating instructions so you will know how to operate your model properly. After you have finished reading the instructions, put them away in a safe place for future reference.

[For U.S. model] IMPORTANT NOTICE

The serial number for this equipment is located on the rear panel. Please write this serial number on your enclosed warranty card and keep it in a secure area. This is for your security.

WARNING: TO PREVENT FIRE OR SHOCK HAZARD, DO NOT EXPOSE THIS APPLIANCE TO RAIN OR MOISTURE.

THE STANDBY/ON BUTTON IS SECONDARY CONNECTED AND THEREFORE DOES NOT SEPARATE THE UNIT FROM MAINS POWER IN STANDBY POSITION.

IMPORTANT



The lightning flash with arrowhead symbol, within an equilateral triangle, is intended to alert the user to the presence of uninsulated "dangerous voltage" within the product's enclosure that may be of sufficient magnitude to constitute a risk of electric shock to persons.

CAUTION

RISK OF ELECTRIC SHOCK
DO NOT OPEN

CAUTION: TO PREVENT THE RISK OF ELECTRIC SHOCK, DO NOT REMOVE COVER (OR BACK). NO USER-SERVICEABLE PARTS INSIDE. REFER SERVICING TO QUALIFIED SERVICE PERSONNEL.



The exclamation point within an equilateral triangle is intended to alert the user to the presence of important operating and maintenance (servicing) instructions in the literature accompanying the appliance.

NOTE: This equipment has been tested and found to comply with the limits for a Class B digital device, pursuant to Part 15 of the FCC Rules. These limits are designed to provide reasonable protection against harmful interference in a residential installation. This equipment generates, uses, and can radiate radio frequency energy and, if not installed and used in accordance with the instructions, may cause harmful interference to radio communications. However, there is no guarantee that interference will not occur in a particular installation. If this equipment does cause harmful interference to radio or television reception, which can be determined by turning the equipment off and on, the user is encouraged to try to correct the interference by one or more of the following measures:

- Reorient or relocate the receiving antenna.
- Increase the separation between the equipment and receiver.
- Connect the equipment into an outlet on a circuit different from that to which the receiver is connected.
- Consult the dealer or an experienced radio/TV technician for help.

Information to User

Alteration or modifications carried out without appropriate authorization may invalidate the user's right to operate the equipment.

[For Canadian model]

This Class B digital apparatus complies with Canadian ICES-003.

[Pour le modèle Canadien]

Cet appareil numérique de la classe B est conforme à la norme NMB-003 du Canada.

[For Canadian model]

CAUTION: TO PREVENT ELECTRIC SHOCK, DO NOT USE THIS (POLARIZED) PLUG WITH AN EXTENSION CORD, RECEPTACLE OR OTHER OUTLET UNLESS THE BLADES CAN BE FULLY INSERTED TO PREVENT BLADE EXPOSURE.

ATTENTION: POUR PREVENIR LES CHOCES ELECTRIQUES NE PAS UTILISER CETTE FICHE POLARISEE AVEC UN PROLONGATEUR, UNE PRISE DE COURANT OU UNE AUTRE SORTIE DE COURANT, SAUF SI LES LAMES PEUVENT ETRE INSERES A FOND SANS EN LAISSER AUCUNE PARTIE A DECOUVERT.

ATTENTION: AFIN DE PREVENIR TOUS RISQUES DE CHOC ELECTRIQUE OU DE DEBUT D'ENCENDIE, NE PAS EXPOSER CET APPAREIL A L'HUMIDITE OU A LA PLUIE.

LE BOUTON STANDBY/ON EST RACCORDE SECONDAIREMENT ET PAR CONSEQUENT NE SEPARA PAS L'APPAREIL DE L'ALIMENTATION SECTEUR SUR LA POSITION D'ATTENTE.

[For U.S. model]



As an ENERGY STAR® Partner, Pioneer Corporation has determined that this product meets the ENERGY STAR® guidelines for energy efficiency.

K001 En

IMPORTANT SAFETY INSTRUCTIONS

READ INSTRUCTIONS — All the safety and operating instructions should be read before the product is operated.

RETAIN INSTRUCTIONS — The safety and operating instructions should be retained for future reference.

HEED WARNINGS — All warnings on the product and in the operating instructions should be adhered to.

FOLLOW INSTRUCTIONS — All operating and use instructions should be followed.

CLEANING — Unplug this product from the wall outlet before cleaning. The product should be cleaned only with a polishing cloth or a soft dry cloth. Never clean with furniture wax, benzene, insecticides or other volatile liquids since they may corrode the cabinet.

ATTACHMENTS — Do not use attachments not recommended by the product manufacturer as they may cause hazards.

WATER AND MOISTURE — Do not use this product near water — for example, near a bathtub, wash bowl, kitchen sink, or laundry tub; in a wet basement; or near a swimming pool; and the like.

ACCESSORIES — Do not place this product on an unstable cart, stand, tripod, bracket, or table. The product may fall, causing serious injury to a child or adult, and serious damage to the product. Use only with a cart, stand, tripod, bracket, or table recommended by the manufacturer, or sold with the product. Any mounting of the product should follow the manufacturer's instructions, and should use a mounting accessory recommended by the manufacturer.

CART — A product and cart combination should be moved with care. Quick stops, excessive force, and uneven surfaces may cause the product and cart combination to overturn.



VENTILATION — Slots and openings in the cabinet are provided for ventilation and to ensure reliable operation of the product and to protect it from overheating, and these openings must not be blocked or covered. The openings should never be blocked by placing the product on a bed, sofa, rug, or other similar surface. This product should not be placed in a built-in installation such as a bookcase or rack unless proper ventilation is provided or the manufacturer's instructions have been adhered to.

POWER SOURCES — This product should be operated only from the type of power source indicated on the marking label. If you are not sure of the type of power supply to your home, consult your product dealer or local power company.

LOCATION — The appliance should be installed in a stable location.

NONUSE PERIODS — The power cord of the appliance should be unplugged from the outlet when left un-used for a long period of time.

GROUNDING OR POLARIZATION

- If this product is equipped with a polarized alternating current line plug (a plug having one blade wider than the other), it will fit into the outlet only one way. This is a safety feature. If you are unable to insert the plug fully into the outlet, try reversing the plug. If the plug should still fail to fit, contact your electrician to replace your obsolete outlet. Do not defeat the safety purpose of the polarized plug.

- If this product is equipped with a three-wire grounding type plug, a plug having a third (grounding) pin, it will only fit into a grounding type power outlet. This is a safety feature. If you are unable to insert the plug into the outlet, contact your electrician to replace your obsolete outlet. Do not defeat the safety purpose of the grounding type plug.

POWER-CORD PROTECTION — Power-supply cords should be routed so that they are not likely to be walked on or pinched by items placed upon or against them, paying particular attention to cords at plugs, convenience receptacles, and the point where they exit from the product.

OUTDOOR ANTENNA GROUNDING — If an outside antenna or cable system is connected to the product, be sure the antenna or cable system is grounded so as to provide some protection against voltage surges and built-up static charges. Article 810 of the National Electrical Code, ANSI/NFPA 70, provides information with regard to proper grounding of the mast and supporting structure, grounding of the lead-in wire to an antenna discharge unit, size of grounding conductors, location of antenna-discharge unit, connection to grounding electrodes, and requirements for the grounding electrode. See Figure A.

LIGHTNING — For added protection for this product during a lightning storm, or when it is left unattended and unused for long periods of time, unplug it from the wall outlet and disconnect the antenna or cable system. This will prevent damage to the product due to lightning and power-line surges.

POWER LINES — An outside antenna system should not be located in the vicinity of overhead power lines or other electric light or power circuits, or where it can fall into such power lines or circuits. When installing an outside antenna system, extreme care should be taken to keep from touching such power lines or circuits as contact with them might be fatal.

OVERLOADING — Do not overload wall outlets, extension cords, or integral convenience receptacles as this can result in a risk of fire or electric shock.

OBJECT AND LIQUID ENTRY — Never push objects of any kind into this product through openings as they may touch dangerous voltage points or short-out parts that could result in a fire or electric shock. Never spill liquid of any kind on the product.

SERVICING — Do not attempt to service this product yourself as opening or removing covers may expose you to dangerous voltage or other hazards. Refer all servicing to qualified service personnel.

DAMAGE REQUIRING SERVICE — Unplug this product from the wall outlet and refer servicing to qualified service personnel under the following conditions:

- When the power-supply cord or plug is damaged.
- If liquid has been spilled, or objects have fallen into the product.
- If the product has been exposed to rain or water.
- If the product does not operate normally by following the operating instructions. Adjust only those controls that are covered by the operating instructions as an improper adjustment of other controls may result in damage and will often require extensive work by a qualified technician to restore the product to its normal operation.
- If the product has been dropped or damaged in any way.
- When the product exhibits a distinct change in performance — this indicates a need for service.

REPLACEMENT PARTS — When replacement parts are required, be sure the service technician has used replacement parts specified by the manufacturer or have the same characteristics as the original part. Unauthorized substitutions may result in fire, electric shock, or other hazards.

SAFETY CHECK — Upon completion of any service or repairs to this product, ask the service technician to perform safety checks to determine that the product is in proper operating condition.

WALL OR CEILING MOUNTING — The product should not be mounted to a wall or ceiling.

HEAT — The product should be situated away from heat sources such as radiators, heat registers, stoves, or other products (including amplifiers) that produce heat.

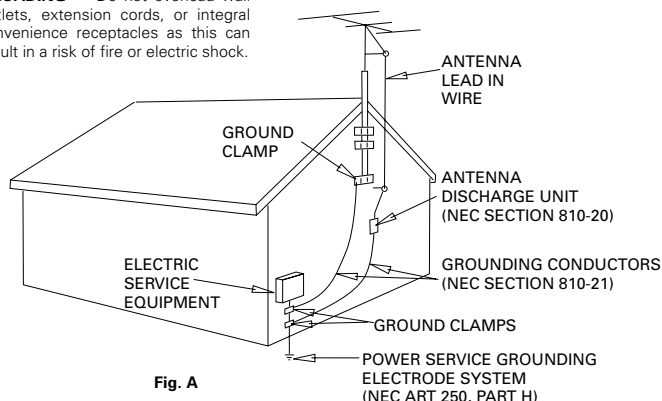

Fig. A

NEC — NATIONAL ELECTRICAL CODE

Quick Start Guide

This is a quick guide to setting up your new receiver so you can get home theater surround sound. For more details on any of the information presented here check the main section of the manual.

Before making or changing the connections, switch off the power and disconnect the power cord from the AC outlet.

1 Hooking Up Your DVD Player & TV

In order to use Dolby Digital/DTS soundtracks which are at the heart of home theater you need to hook up your DVD player with digital audio connections. You can do this by either a coaxial or an optical connection, **you don't need to do both**. The quality of these two types of connections is the same but since some digital components only have one type of digital terminal you need to figure out which yours has and hook it up to the appropriate terminal on the receiver. In order to do this you will need the proper cable. For coaxial connections you can use a regular RCA stereo cord or the specially-made coaxial cords, they have the same type of plugs. For optical connections you will need a special optical cord which you can buy at your local stereo store. Also hook up the video connection of your DVD player, the analog audio (for recording the audio on DVDs, use regular RCA stereo cords), and your TV (it's easiest to use a regular composite RCA video cords) as shown below. It is important that you hook up your TV (or monitor) in order to see a video image as well as the on screen displays (OSDs) shown by this receiver (for more on p. 16-17). We also recommend hooking up your all your digital components to analog audio jacks. For this you can use regular RCA stereo cords.

Coaxial Digital Connection

If your DVD player has a coaxial terminal (not a PCM-only output) for the audio out hook it up using this terminal. Follow the diagram below. This is the best scenario, as you will be able to follow the default settings of this receiver and won't need to assign the digital inputs.

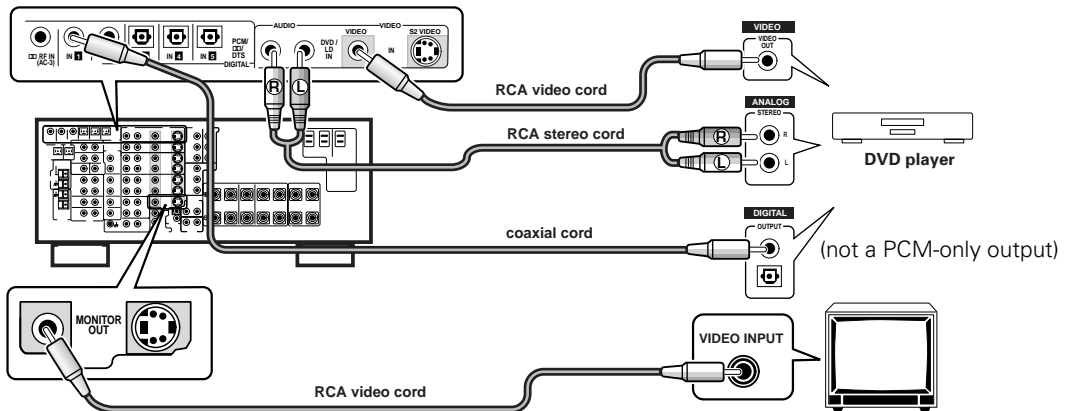

Optical Digital Connection

If your DVD player has an optical terminal (not a PCM-only output) for the audio out you can hook it up using this following the below diagram. You will need to assign the digital input (tell the receiver which input you put your DVD digital audio into). See page VI for this.

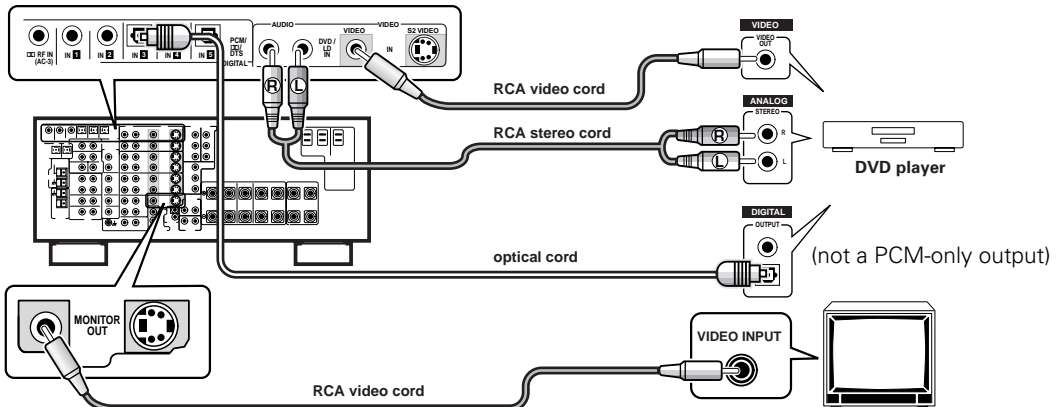

2 Speaker Connections

Home theater is designed to be setup with five, or seven speakers (front left & right; center; surround left & right; and, optimally, surround back left & right) and a subwoofer but you can use this receiver with fewer speakers. Hook up the speakers you have to the A speaker terminals on the back of the receiver. If you only have two speakers hook them up as "FRONT." If you have three hook up the single speaker as "CENTER." Follow the diagram on p. 19 in order to hook up all your speakers. A center speaker is very important for watching films because the dialog comes from the center speaker in digital soundtracks. **If you do not have a CENTER speaker you must tell the receiver the CENTER channel is OFF or when you listen to digital soundtracks you won't hear any dialog.** Use the instructions on page 34-35 in order to do this.

Follow the diagram below to hook up an additional amplifier in order to use surround back speakers. These speakers are important to hear all the sound channels on new, eight channel home theater DVDs. The diagram below also explains how to hook up a subwoofer which provides realistic bass sounds.

Make sure you connect the speaker on the right to the right terminal and the speaker on the left to the left terminal. Also make sure the positive and negative (+/-) terminals on the amplifier match those on the speakers.

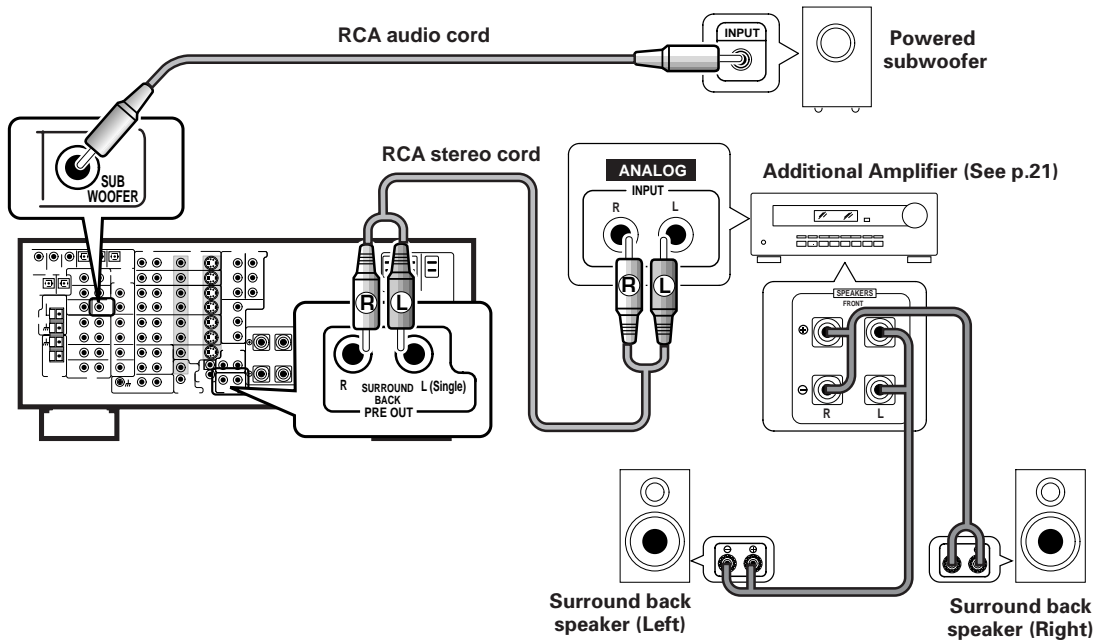

3 Setting up the Remote Control & Unit

- 1 Put the batteries in the REMOTE CONTROL.
- 2 Plug the main unit into a wall outlet.
- 3 Press the  STANDBY/ON button to put the receiver in ON mode.

4 Digital Input Assignment

This is only necessary if you did not hook up your DVD to DIGITAL IN 1, as in the first diagram on p. IV.

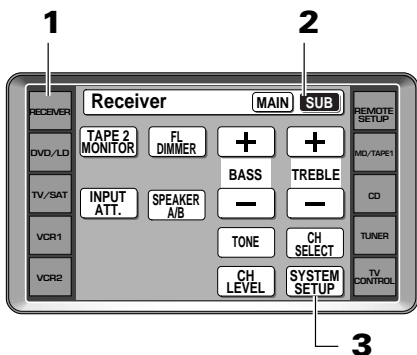

1 Turn on the receiver and your TV, press the RECEIVER on the remote control.

2 Press the SUB button on the remote control.

3 Press the SYSTEM SETUP button.

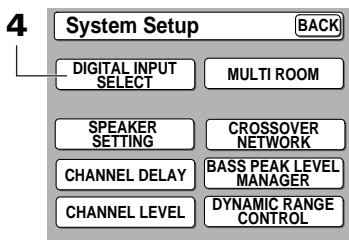

4 Press the DIGITAL INPUT SELECT button.

5 Press the DIGITAL IN 3 button which should correspond to the digital in jack you hooked your DVD up to (as in the optical digital connection diagram on p.IV).

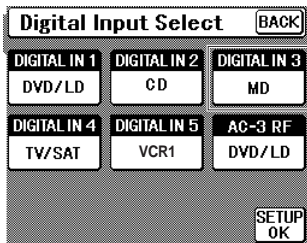

6 At the bottom of the remote control the functions available will appear. Press the DVD/LD button.

7 Press the SETUP OK button.

Hold the remote control pointed towards the receiver until you see the "RECEIVED" display on the receiver.

If "ERROR" flashes in the display, perform the setup operations from the first step again.

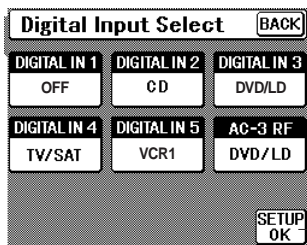
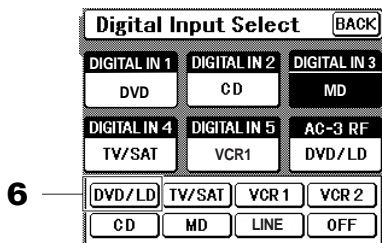

5 Playing a DVD with Surround Sound

1 Turn on the receiver, your TV, and the DVD player.

2 Press the STANDARD button on the front panel for the basic surround sound setting.

You can also press the remote control RECEIVER button and then press the STANDARD button on that screen.

3 Press the DVD/LD button on the remote control.

You should see "DVD/LD" in the display on the receiver.

4 Play a DVD.

6 For Better Surround Sound

1 Go through the entire "system setup" procedures as outlined on pages 32-41 of this instruction manual.

If you don't hook up any other components with digital audio or do so following the default settings of the receiver (see p. 14) you won't have to assign any more digital inputs, but many other adjustments will improve the sound tremendously.

2 Experiment with the different sound settings offered with the DDD / DTS and DSP buttons.

For more information see p. 43-47.

3 As mentioned above you should go through the "speaker setup" instructions on pages 32-41 to set up your speakers properly. If you don't do this you, at least, need to make sure the CENTER channel is turned off if you don't have a center speaker. Use the instructions on pages 32-35 to get the display below on your remote control.

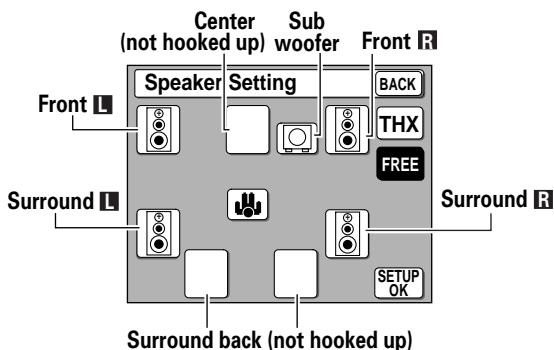

If you don't have a center speaker press the CENTER button until the box appears empty. Then press the SETUP OK button to EXIT and go back to the System Setup screen.

Features

Multi Channel Stereophonic Concept

The VSX-39TX receiver is constructed with Pioneer's industry-leading multi channel stereophonic concept. This well-developed approach to receiver circuitry takes the high level base technology that, up until now, has been only used for stereo equipment and applies it to multi-channel audio-visual receivers. The result is that the product, in addition to being expertly built, and gives you optimal sound reproduction of DVDs, other multi channel sources and stereo sources as well. This receiver is designed capture to a true reproduction of the intentions of a filmmaker or music producer at the time they were mastering the soundtrack in the studio. It incorporates 5 independent 120 watt built in power amplifiers, with high-performance Hex power Direct Power MOS FET output transistors. This construction provides improved linearity and accurate representation of each channel for true high fidelity reproduction from even the most demanding Dolby Digital and DTS program sources. In addition, the amplifier uses Direct Construction and a Direct Current Bus Bar to give the purest sound available. All these elements consolidated in one receiver afford the listener a new surround sound experience in his or her home.

Universal Player Compatibility

This receiver incorporates the latest technology and is able to handle cutting edge audio formats, like DVD Audio, which are just hitting the market. Its high compatibility offers a variety of inputs to decode all types of sources at the highest possible quality. The receiver's multi channel in connections lets you hook up eight discrete channels of audio. It also has multi channel direct inputs and the ability to decode the cutting edge formats.

Decoding of Next Generation Digital Source Film Formats

Built into this receiver is the latest in film sound format technology. This technology includes the recent THX SURROUND EX and HOME THX CINEMA surround modes which employ special processing to allow you to enjoy movie soundtracks with the same level of power and realism you experience in well-designed movie theaters. The THX SURROUND EX mode has been especially designed to incorporate surround back channels that some new source material uses. This receiver has the ability to decode Dolby Digital, Dolby Pro Logic and DTS (Digital Theater Systems) sources, which are the standards of home theater today. It also offers component video terminals for the sharpest video transmission available to the consumer.

Manufactured under license from Lucasfilm Ltd. U.S. patent numbers 5,043,970; 5,189,703; and/or 5,222,059. European patent number 0323830. Other U.S. and foreign patents pending. Lucasfilm and THX are registered trademarks of Lucasfilm Ltd. Surround EX is a trademark of Dolby Labs. Used under authorization.

"DTS", "ES" and "DTS Digital Surround" are trademarks of Digital Theater Systems, Inc. Manufactured under licence from Digital Theater Systems, Inc.

Manufactured under license from Dolby Laboratories. "Dolby", "AC-3", "Pro Logic", and double-D symbol are trademarks of Dolby Laboratories. Confidential unpublished works. © 1992 - 1997 Dolby Laboratories. All rights reserved.

Advanced Theater Modes & DSP Surround Modes

Advanced Theater modes enhance the sound of either film or music so a more dramatic effect can be achieved. The four modes are each designed to accentuate specific sound qualities, giving the listener a wide range of possibilities. DSP (Digital Signal Processing) surround modes give you the capability of transforming your living room into seven different sonic environments when listening to music.

Midnight Mode, Digital Noise Reduction & 7 Channel Tone Control

The Midnight mode allows you to obtain excellent surround sound effects even when listening at low volumes, something that was previously impossible. Digital noise reduction filters out unwanted noise from recordings to give you a clearer sound and the 7 channel tone control allows you to adjust the treble and bass of each channel individually to suit your listening tastes.

New LCD Touch Panel Remote Control

This touch sensitive screen remote control is the latest in convenient technology. It's easily viewed screen can access a huge amount of different buttons. Instead of the old method where one button had to perform many tasks, this remote can instantly change screens, allowing one button to have just one, clearly marked purpose. This remote can be used to operate a variety of other components simply by recalling the appropriate setup codes or by using the learning function to teach the remote control new commands. In addition, you can personalize your remote control with the key rename and item memo functions so that it reflects your personal home set up. The remote also has a lock feature to make sure none of the settings are changed accidentally.

The Energy-saving Design

8 This unit is designed to use less than 1 W of energy when the receiver is in standby mode.

Table of Contents

Before You Start	10
Checking the Supplied Accessories	10
How to Use This Manual	10
Preparing the Remote Control	10
Loading the batteries	10
Remote Control Battery Alarm	11
The Touch Pen & Lock	11
Remote Control Cushions	11
Operating range of remote control unit	11
Installing the Receiver	11
Opening the Front Panel	11
Connecting Your Equipment	12
Audio Components	12
Cassette deck placement	12
Digital Connections	13
Example Connection for a DVD/LD or LD player	14
Digital Input Assignment	14
Video Components	15
Satellite TV Components	16
TV	17
Multi Channel Input (External Decoder)	17
Connecting the Radio Antennas	18
Using outdoor antennas	18
Speakers	19
Placing Your Speakers	20
Speaker placement	20
Connecting additional amplifiers	21
Plugging In	21
Displays & Controls	22
Front Panel	22
Display	24
Remote Control	26
Basic Receiver LCD Screens	27
Receiver MAIN screen	27
Receiver SUB screen	28
Initial Set Up	29
On Screen Display	29
Switching video system between	
PAL and NTSC	29
Setting Up the Remote Control	30
Setting Up for Surround Sound	32
DIGITAL INPUT SELECT	33
SPEAKER SETTING	34
CHANNEL DELAY	36
CHANNEL LEVEL	37
CROSSOVER NETWORK	39
BASS PEAK LEVEL MANAGER	40
DYNAMIC RANGE CONTROL	41
DUAL MONO SETTING	42
Basic Playback	43
Sound Modes	43
STANDARD modes	43
HOME THX CINEMA modes	43
ADVANCED THEATER modes	44
DSP mode	45
STEREO modes	45
Selecting a Sound Mode	46
Using surround sound	46
Playing Sources with	
Dolby Digital or DTS Sound	47
Playing Sources with Stereo Sound	48
Switching ANALOG/DIGITAL Signal Input	49

Reducing Noise During Playback	
(DIGITAL NR Function)	50
Listening in MIDNIGHT Mode	50
Listening in LOUDNESS Mode	51
Adjusting Bass and Treble (Tone Control)	51
MULTI CHANNEL IN Playback	52
MULTI CHANNEL IN Setting	52
96kHz 24bit Performance	52
Direct Playback	53
Adjusting the Brightness of the Display	53

Using the Tuner	54
Automatic and Manual Tuning	54
MPX Mode	54
Direct Access Tuning	55
Memorizing Frequently Used Stations	56
Recalling Memorized Stations	57

Remote Control of Other Components

58	
Setting Up the Remote Control to Control Other	
Components	58
Recalling Settings Stored in the Remote Control	58
Learning Mode: Programming Signals	
from Other Remote Controls	60
Locking the Settings	61
Item Memo	62
Key Rename	63
Using Remote Control with Other Components	64
DVD or LD player operations	64
CD player operations	65
MD operations	66
TV operations	67
CATV operations	68
STB (DTV) operations	68
STB (satellite tuner) operations	69
Cassette deck operations	70
VCR operations	71
Other screen for preset operations	71

Using Other Functions

72	
Recording from Audio Components	72
Recording from Video Components	72
Video Select	73
Multi Operations	74
Performing multi operations	75
System OFF	76
Using SYSTEM OFF	77
Setting up the DIRECT FUNCTION	78
Resetting the Remote Control	78
Multi-Room	79
MULTI-ROOM connections	79
MULTI-ROOM set up	80
Using the front panel with the	
MULTI-ROOM system	81
Using the remote control with the	
MULTI-ROOM system	82
The PIONEER SR System Operating other	
PIONEER components	83

Techno Tidbits & Problem-solving ...

84	
Dolby Digital	84
DTS	85
THX	85
Troubleshooting	84
Specifications	87

Before You Start

Checking the Supplied Accessories

Please check that you have received all of the following supplied accessories.



FM wire Antenna



AM Loop Antenna

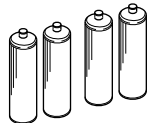

"AA" IEC LR6
batteries x 4

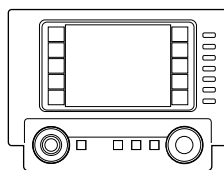

Remote Control Unit



Touch Pen
(attached to the back
of the remote control)

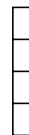

Cushion for
Remote x 4

Operating Instructions

How to Use This Manual

This manual is for the VSX-39TX Audio/Video Multi-Channel Receiver.

This manual is divided into three main sections which will tell you how to setup and use the unit :

PREPARATION

First carry out the tasks below in this "Before You Start" section to prepare the remote control, then connect the receiver to your other components as described in "Connecting Your Equipment" (p.12-21). Take special care to connect your digital equipment like DVDs and LDs properly to be able to take advantage of the receiver's surround sound systems. To learn about a specific button, control, or indicator, see "Displays & Controls" starting on p.22.

SET UP

Performing the tasks in "Initial Set Up" (from p.29) is essential to get proper surround sound.

OPERATION

To play some music or soundtrack refer to "Basic Playback" on p.43. "Using the Tuner" (p.54) explains

how to use the radio of this unit. Doing the operations in "Remote Control of Other Components" (p.58) is highly recommended so you can use this unit's remote control for all your components. "Using Other Functions" (p.72) explain the other possibilities of the receiver.

"Techno Tidbits & Problem-solving" (p.84) provide detailed technical information and a troubleshooting guide.

The following marks and symbols are used throughout the manual:



Provides additional information, precautions, and advice.



Indicates a blinking button, indicator, or display.



Indicates a steadily lit button, indicator, or display.

Preparing the Remote Control

Loading the batteries

Load the batteries into the remote control as shown below. The remote control uses a lot of power due to the LCD display so please use alkaline batteries. Depending on individual use you may have to change the batteries fairly often but most users should be able to get an average of 1-3 months of battery life. When you notice a decrease in the operating range or if the alarm sounds (see next page), replace all batteries with new ones.

NOTE: After replacing the batteries, the touch panel will need re-adjusting (see p.30-31).

1

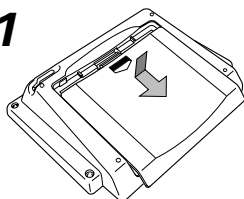

2

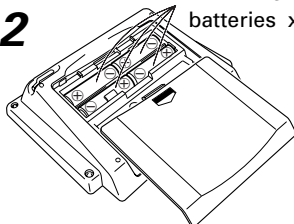

3

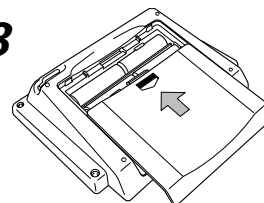

CAUTION!

Incorrect use of batteries may result in such hazards as leakage and bursting. Observe the following precautions.

- Never use new and old batteries together.
- Insert the plus and minus sides of the batteries properly according to the marks in the battery case.
- Batteries with the same shape may have different voltages. Do not use different batteries together.
- When disposing of used batteries, please comply with governmental regulations or environmental public institution's rules that apply in your country / area.

Remote Control Battery Alarm

When the batteries get too weak to operate the remote control properly an alarm will sound and a warning screen will appear on the remote. Change the batteries as shown on the previous page.

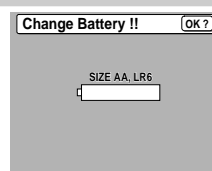

The Touch Pen & Lock

The touch pen is located in the back right-hand corner of the remote control. Take it out by sliding your finger along the bottom right edge of the remote control and then grasping the pen with thumb and forefinger.

The lock switch is located in the top right-hand corner on the back of the remote control. When this switch is set to LOCK you can't use the buttons on the remote control. This is helpful to prevent you from mistakenly pushing a button. For normal use keep the switch set in USE.

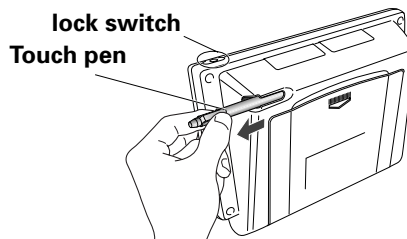

Remote Control Cushions

Apply the cushions to the feet of the remote control as shown in the diagram right.

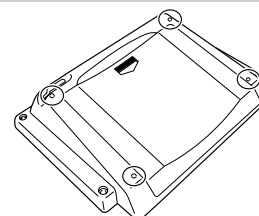

Operating range of remote control unit

The area in which you can use the remote control to operate the VSX-39TX is fairly large. To use, point the remote control toward the remote sensor on the front panel of this unit while within the range shown right.

Remote control may not function properly if:

- There are obstacles between the remote control and the remote sensor.
- Direct sunlight or fluorescent light is shining onto the remote sensor.
- The receiver located near a device emitting infrared rays.
- Operated simultaneously with another remote control which uses infrared rays.

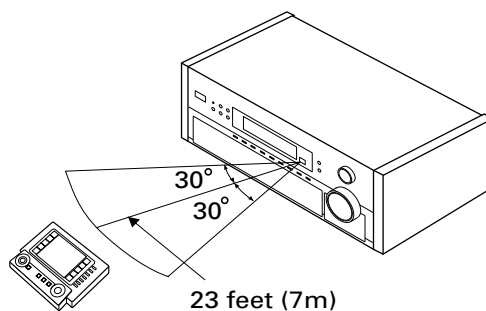

Installing the Receiver

Please note:

- Do not place objects directly on top of this unit. This would prevent proper heat dispersal.
- When installing in a rack, shelf, etc., be sure to leave more than 8 inches of space above the receiver.

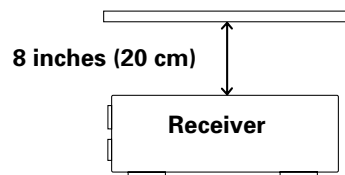

Opening the Front Panel

To open the front panel push gently on the lower third of the panel with your finger.

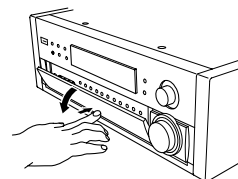

Connecting Your Equipment

Audio Components

To begin set up connect your audio components to the jacks as shown below. These are all analog connections and your analog audio components (turntable, cassette deck) use these jacks. Remember that for components you want to record with you need to hook up four plugs (a set of stereo ins and a set of stereo outs), but for components that only play (like a turntable) you only need to hook up one set of stereo plugs (two plugs). To use DTS or Dolby Digital surround sound features you must hook up your digital components to the digital inputs (see p. 13). We also recommend hooking up your digital components to analog audio jacks. If you want to record to/from digital components (like an MD) to/from analog components you must hook up your digital equipment with these analog connections. See p.13 &14 for more on digital connections.

Before making or changing the connections, switch off the power and disconnect the power cord from the AC outlet.

*The arrows indicate the direction of the audio signal.

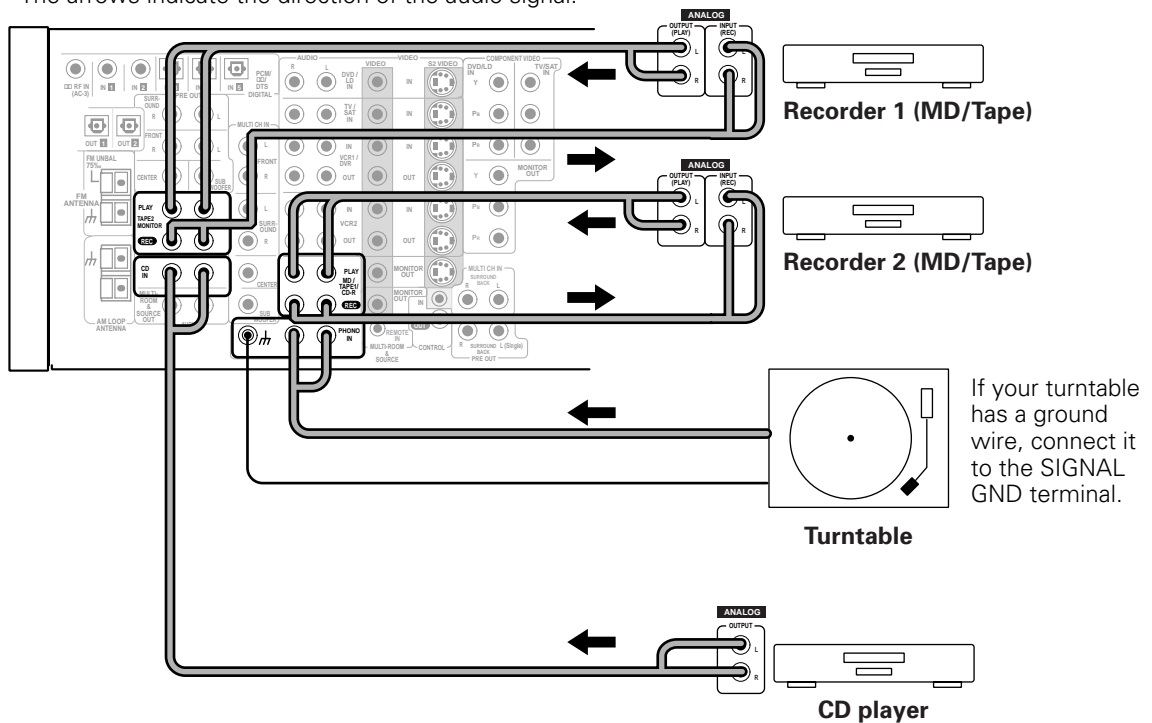

Please don't hook up any other component to the phono jacks other than a turntable. It could damage the equipment. If your turntable has a built-in amplifier please hook it up to an input other than PHONO.

■ Audio cords

Use audio cords (not supplied) to connect the audio components.

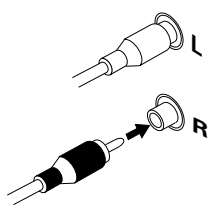

Connect red plugs to R (right) and white plugs to L (left).

Be sure to insert completely.

Cassette deck placement

Depending on where the cassette deck is placed, noise may occur during playback of your cassette deck which is caused by leakage flux from the transformer in the receiver. If you experience noise, move the cassette deck farther away from the receiver.

Digital Connections

In order to use Dolby Digital/DTS soundtracks which are at the heart of home theater you need to make digital audio connections. You can do this by either a coaxial or an optical connection (you don't need to do both). The quality of these two types of connections is the same but since some digital components only have one type of digital terminal, it is a matter of matching like with like (for example, the coaxial out from the component to coaxial in on the receiver). The VSX-39TX has two coaxial and three optical inputs for a total of five digital inputs. A DVD/LD player or LD player should be connected to a digital jack and the special RF jack (if the LD has one) as well as a pair of analog jacks (see the next page). If possible hook up your digital equipment in accordance with this receiver's default settings, see "Digital Input Assignment", below left, in order to do this. We also recommend hooking up your digital components to analog audio jacks in order to make recording from some digital sources which may be copy protected.

Connect your digital components as shown below.

There are two optical digital out jacks (the MD recorder is connected to one in the diagram below). If you connect this to the optical input on a digital recorder (currently these include MD, DAT and CD-R) you can make direct digital recordings with this unit.

Before making or changing the connections, switch off the power and disconnect the power cord from the AC outlet.

*The arrows indicate the direction of the audio signal.

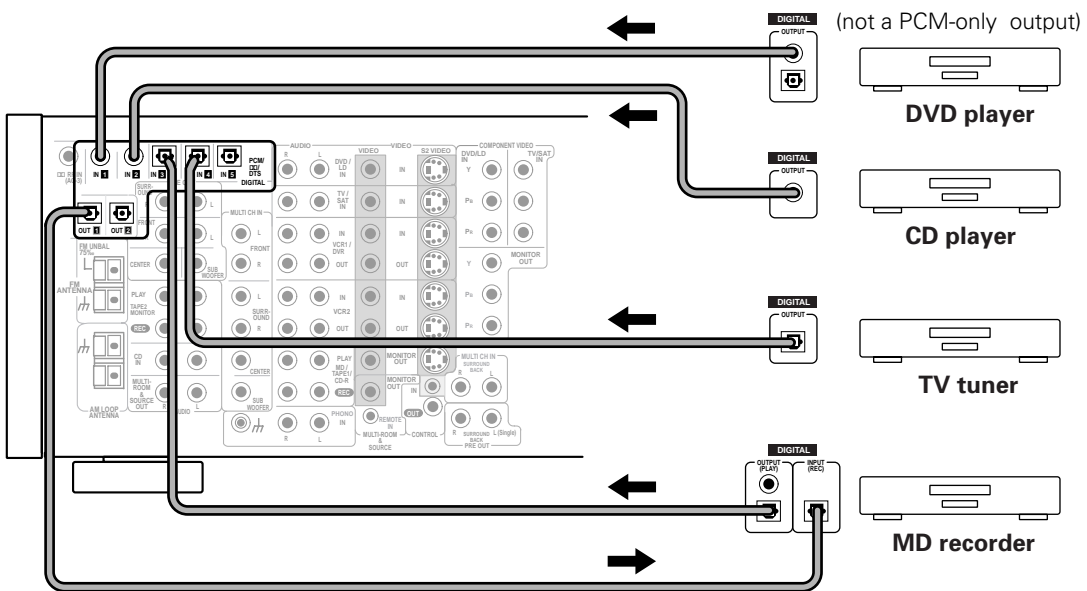

Coaxial cords/Optical cables

Commercially available digital audio coaxial cords (standard video cords can also be used) or optical cables (not supplied) are used to connect digital components to this receiver.

When you use optical digital input or output terminals, pull off the caps and insert the plugs. Be sure to insert completely.

**Coaxial cord
(or standard video cord)**

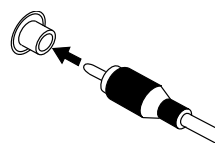

Optical cable

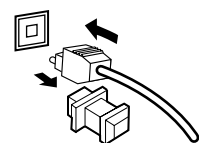

Connecting Your Equipment

Example Connection for a DVD/LD or LD player

Make sure you connect your DVD/LD or LD players using both the **RF** jack and either a coaxial or optical (you don't need to do both of these) digital connections. If your player has an **RF** output this will ensure you can use all LDs (see p. 15).

We also recommend hooking up your digital components to analog audio jacks.

Before making or changing the connections, switch off the power and disconnect the power cord from the AC outlet.

*The arrows indicate the direction of the video signal.

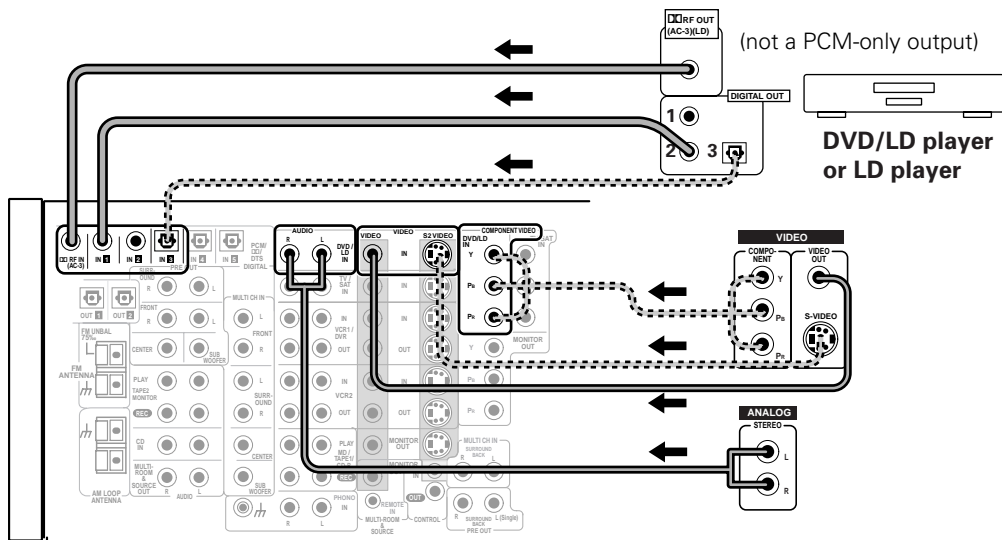

Be sure to make either a digital coaxial or digital optical connection (pictured as DIGITAL jack 1 or DIGITAL jack 3 in this diagram) as well, but you DON'T need to make both.

Also, be sure to assign the jacks to the proper component(s) with the DIGITAL INPUT SELECT procedure (see p.33) if necessary. See the explanation on the left for details.

Digital Input Assignment

Unlike analog connections, the jacks for digital connections are not dedicated to one type of component, they can be used freely. Thus you must tell the receiver what digital component in which jack so your components will be in sync with the names on the remote control buttons and the like. To avoid having to assign the digital inputs you can hook up your equipment in accordance with the receiver's default settings.

The default are:

DIGITAL IN 1: DVD/LD

DIGITAL IN 2: CD

DIGITAL IN 3: MD

DIGITAL IN 4: TV/SAT

DIGITAL IN 5: VCR 1

AC-3 RF: DVD/LD

You will notice that Digital IN 1, for example, is a coaxial jack. If your DVD/LD player only has an optical out jack on it then you won't be able to hook up your components in accordance with the VSX-39TX's default setting. In this case you will need to assign the digital inputs. See DIGITAL INPUT SELECT on p.33 in order to do this.

Video Components

Connect your video components to the jacks as shown below. Regarding a DVD there are two types of connections to make. Hook up your video signal with either component video, S-video, or composite video cords (the quality descends in this order) but remember, the video component you are watching and your TV must be hooked up with same type of video cord or you won't be able to see the picture. For the audio signal, order to use Dolby Digital/DTS you must hook up a digital input. It is also a good idea to hook up your DVD components with analog audio connections as well, since some DVDs may not have a digital audio track. To cover all possible laser discs a DVD/LD player or LD player requires an analog connection and two digital connections (a coaxial or optical and a specialized  RF connection shown at the very top of the first diagram below).

Before making or changing the connections, switch off the power and disconnect the power cord from the AC outlet.

*The arrows indicate the direction of the video signal.

Connecting DVD/LD players

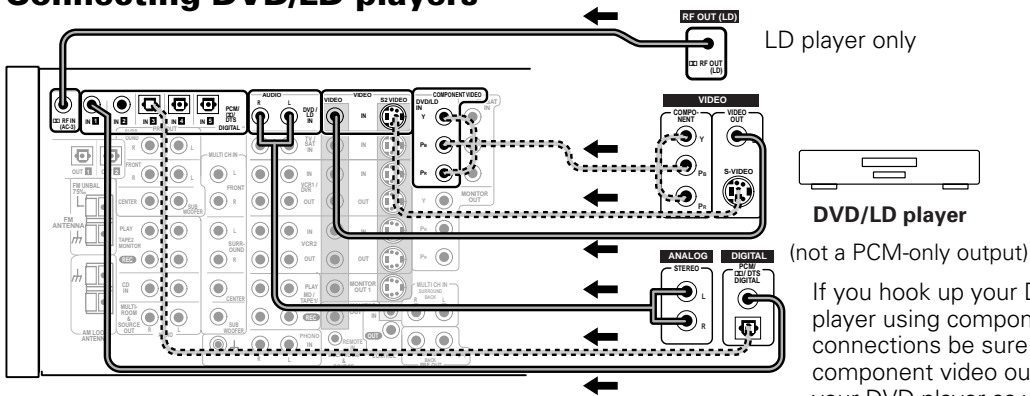

Connecting VCRs or DVRs

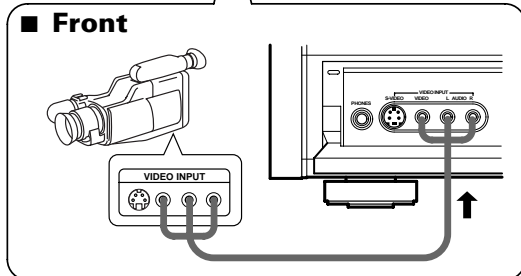
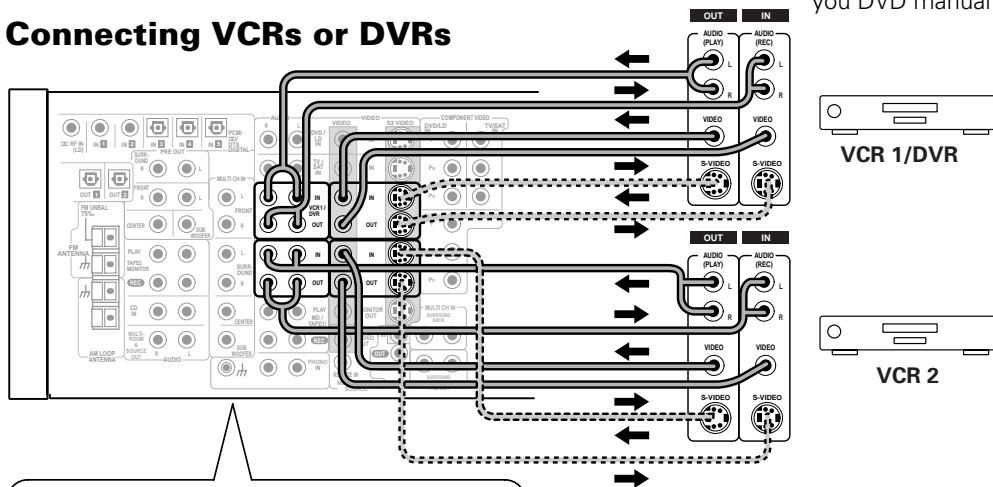

Front video connections are accessed via the front panel input selector as "VIDEO."

memo If your video components have S-video jacks, you could use S-video cords (not supplied) to connect them on the back of the receiver. These jacks are labeled by the Japanese designation "S2" on the VSX-39TX but they are simply S-video jacks.

However, if you use S-video cords for your video hook ups you must also hook up your TV with S-video connections. Conversely, if you use regular composite video cords for video hook ups, you should use them for your TV as well.

Connecting Your Equipment

Satellite TV Components

Connect your satellite TV components to the jacks as shown below. Hook up the video signal with either component video, S-video, or composite video cords (the quality descends in this order) but remember, the video component you are watching and your TV must be hooked up with same type of video cord or you won't be able to see the picture. For the audio signal, order to use digital soundtracks (sometimes broadcast over digital satellite TV) you must hook up a digital input. Use either a coaxial or optical cables, it doesn't matter which (you don't need to use both). It's also a good idea to hook up your audio with analog cables (see below). This connection is called STEREO AUDIO OUT in the diagram.

Before making or changing the connections, switch off the power and disconnect the power cord from the AC outlet.

*The arrows indicate the direction of the TV signal.

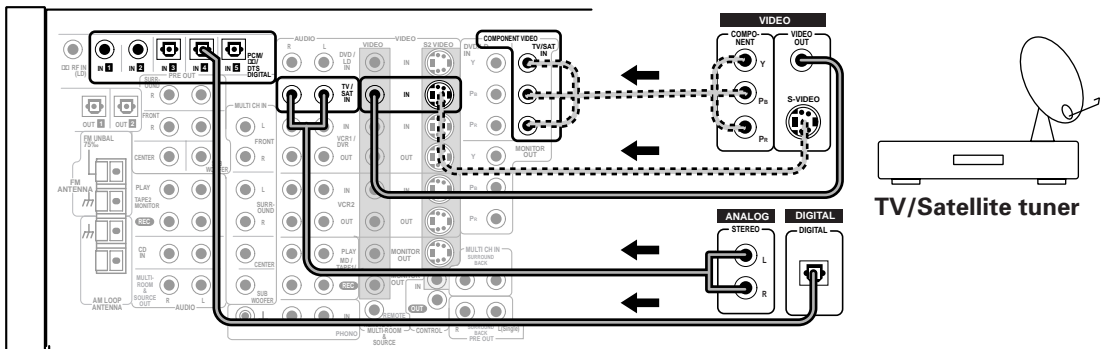

■ Analog audio/video cords

Use audio/video cords (not supplied) to connect the video components and a video cord to connect the monitor TV.

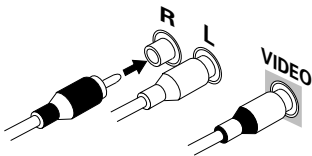

Connect red plugs to R (right), white plugs to L (left), and the yellow plugs to VIDEO.

Be sure to insert completely.

■ Digital audio coaxial cords/ Optical cables

Commercially available digital audio coaxial cords (standard video cords can also be used) or optical cables (not supplied) are used to connect digital components to this receiver.

When you use optical digital input or output terminals, pull off the caps and insert the plugs. Be sure to insert completely.

Digital audio coaxial cord (or standard video cord)

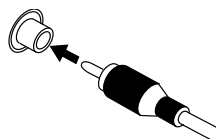

Optical cable

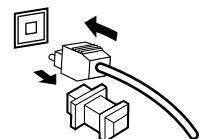

TV

Connect your TV to the jacks as shown below. Hook up the signal with either component video, S-video, or composite video cords (the quality descends in this order) but remember, the video component you are watching and your TV must be hooked up with same type of video cord or you won't be able to see the picture.

Before making or changing the connections, switch off the power and disconnect the power cord from the AC outlet.

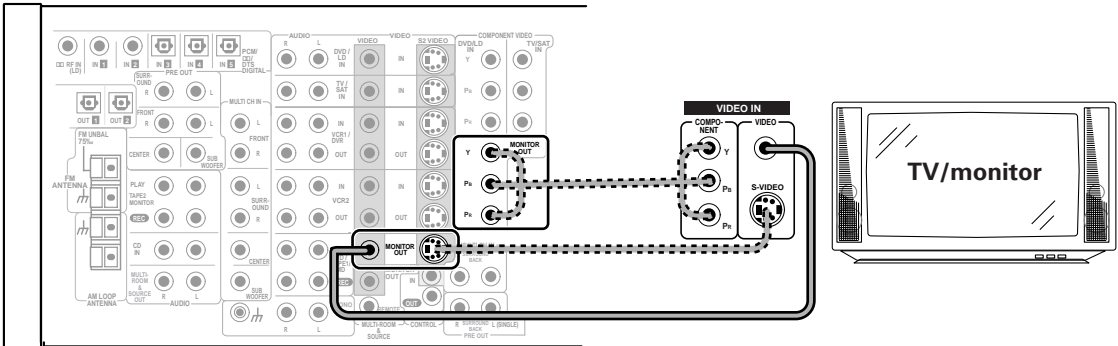

The jack and COMPONENT VIDEO OUT jack can be used to get a TV picture but it doesn't show this receiver's on screen display (OSD).

If you use S video cords to hook up a component the OSDs from the receiver will only be able to be seen on the S video out terminals.

Multi Channel Input (External Decoder)

In some cases you may want to have your source material (DVD, etc.) decoded externally. If you find you need a multi channel external decoder hook one up as shown below, but for most people this component is unnecessary (For more on this see p.52).

Before making or changing the connections, switch off the power and disconnect the power cord from the AC outlet.

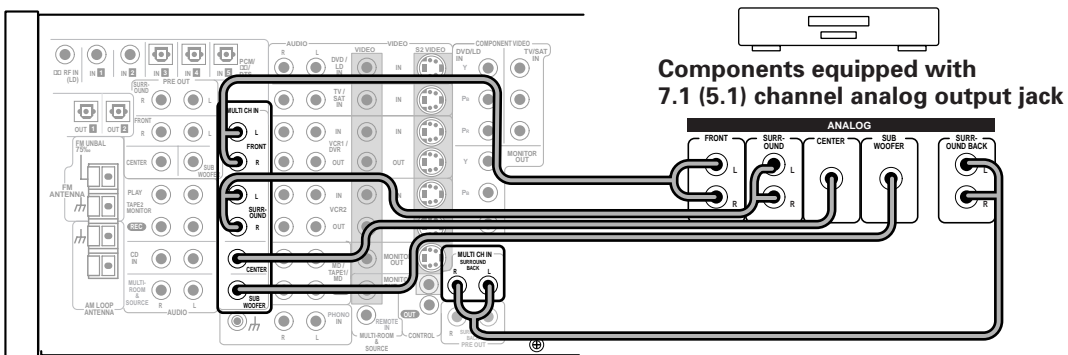

Connecting Your Equipment

Connecting the Radio Antennas

Connect the supplied FM wire antenna and the AM loop antenna to the antenna terminals as shown below. These antennas should provide adequate reception quality in most cases, but connecting outdoor antennas should noticeably improve sound quality.

Before making or changing the connections, switch off the power and disconnect the power cord from the AC outlet.

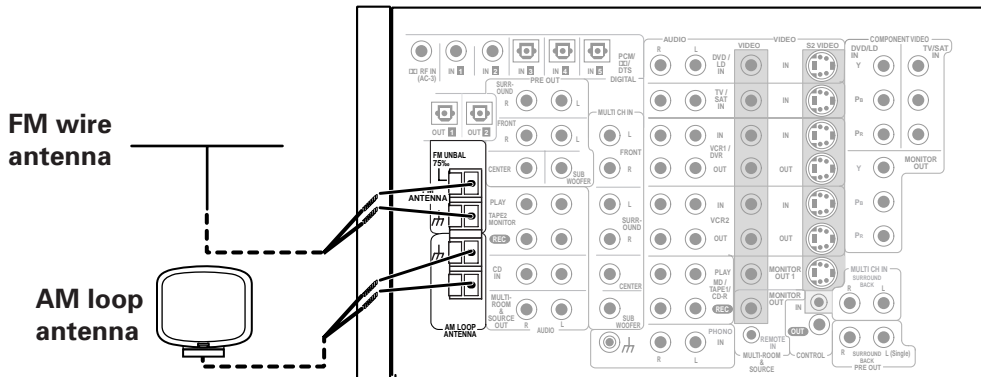

■ AM loop antenna

- ① Assemble the antenna.
- ② Twist exposed wire strands together and insert.
- ③ Attach to a wall, etc. (if desired) and face toward the direction providing the best reception.

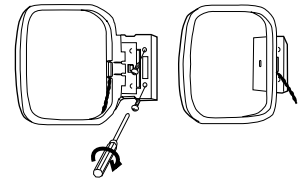
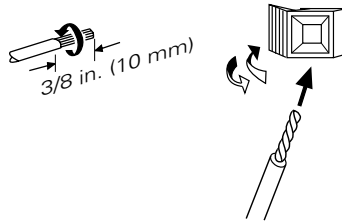
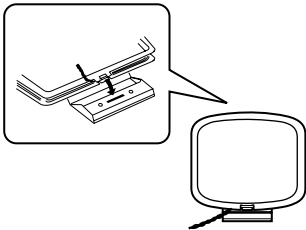

Using outdoor antennas

■ To improve FM reception

Connect an external FM antenna.

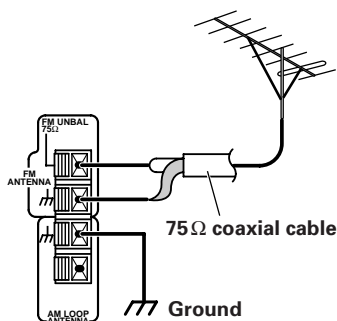

■ To improve AM reception

Connect a 15 to 18 feet (5 – 6 meter) length of vinyl-coated wire to the AM antenna terminal in addition to the supplied AM loop antenna.

For best possible reception, suspend horizontally outdoors.

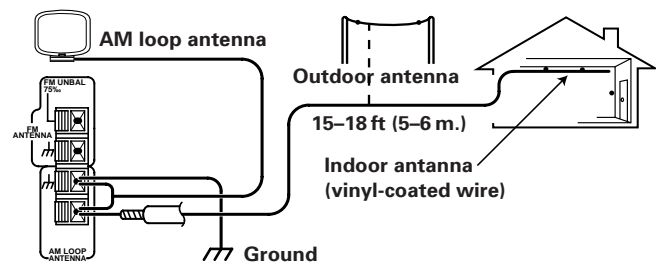

Speakers

A full complement of eight speakers is shown here but, naturally, everyone's home set up will vary. Simply connect the speakers you have in the manner described below. The VSX-39TX will work with just two stereo speakers (called "front" speakers in the diagram) but the receiver is designed to be used with at least three speakers.

One of the latest features of home theater is the use of SURROUND BACK speakers. These speakers add even great realism in movie sound effects and new discs with soundtracks in Dolby Digital or DTS incorporates these channels. In order to be able to use these channels you must hook your SURROUND BACK speakers up to an external amplifier and then connect that to the VSX-39TX, as shown in the diagram below. If you only have one SURROUND BACK speaker hook it up to the SURROUND BACK L (SINGLE) terminal on the back of the receiver.

In general, make sure you connect the speaker on the right to the right terminal and the speaker on the left to the left terminal. Also make sure the positive and negative (+/-) terminals on the receiver match those on the speakers.

Before making or changing the connections, switch off the power and disconnect the power cord from the AC outlet.



The VSX-39TX has two speaker systems, A & B. A is the main system supporting the full complement of surround sound speakers. If you switch on both A & B speaker systems, only front speakers and the subwoofer will be audible. No sound will come from the center or surround speakers but multi channel sources will be down-mixed to the active speakers so no sound will be lost. Similarly, if you choose just the B system you'll only hear the front speakers connected to the B system and multi channel sources will be down-mixed to these two speakers.

Please use speakers with a nominal impedance rated 6Ω-16Ω.

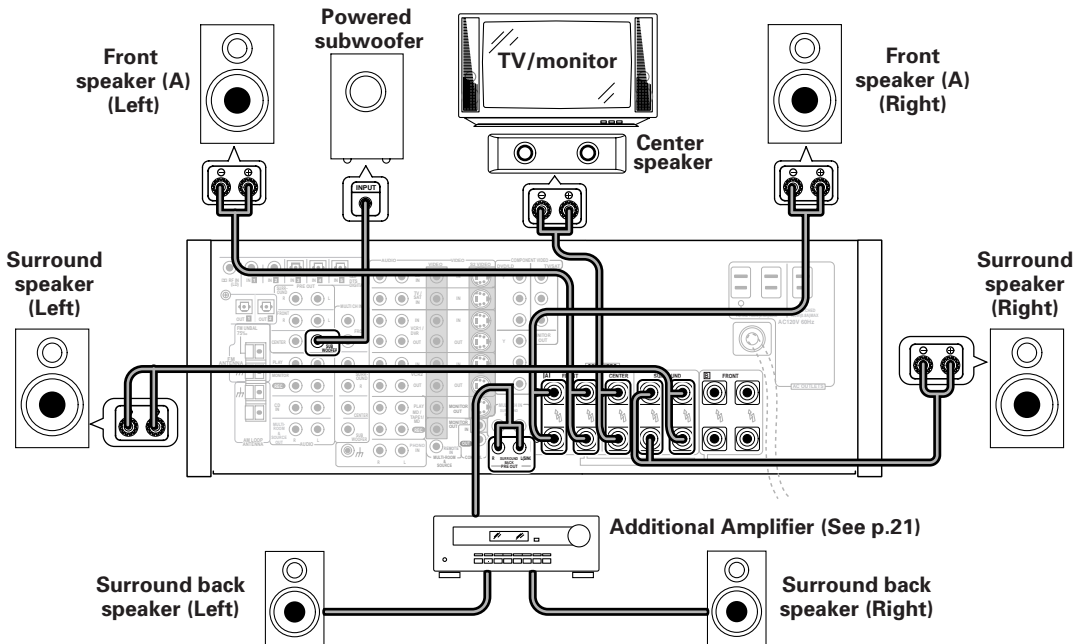

Connecting Your Equipment

■ Speaker terminals

① Twist exposed wire strands together.

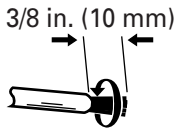

② Loosen speaker terminal and insert exposed wire.

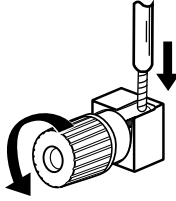

③ Tighten terminal.

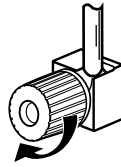

The speaker terminals also accept single banana plugs. (Refer to speaker manual for details.)

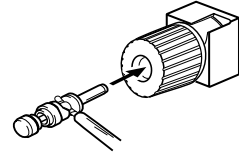

Placing Your Speakers

Proper speaker placement is essential to realize the best sound from your system. The diagram and tips given here are just a rough guide. Be sure to read the instructions that come with your speakers.

Speaker placement

If you have a multiple speaker arrangement the placement of the speakers is extremely important. To achieve the best possible surround sound, install your speakers as shown below. Make sure all speakers are installed securely to prevent accidents and improve sound quality. Be sure to consult your speaker manuals for the best placement of the speakers. Some speakers are designed to be floor-standing but others benefit greatly from speakers stands which raise them off the floor.

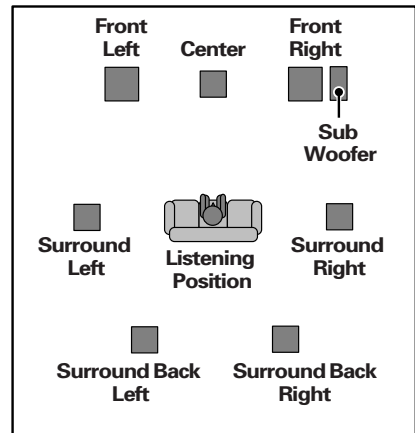

- Install the left and right front speakers at equal distances from the TV.
- When installing speakers near the TV, we recommend using magnetically shielded speakers to prevent possible interference such as distortion in the color of the TV screen. If you do not have magnetically shielded speakers and notice discoloration of the TV screen, place the speakers farther away from the TV.
- Install the center speaker above or below the TV so that the sound of the center channel is localized at the TV screen.

CAUTION:

When installing the center speaker on top of the TV, be sure to secure it with tape or some other suitable means. Otherwise, the speaker may fall from the TV due to external shocks such as earthquakes, and it may lead to endangering those nearby or damaging the speaker.

- If possible, install the surround speakers slightly above ear level.
- It may be difficult to obtain a cohesive surround effect if the surround speakers are installed farther away from the listening position than the front and center speakers.

Connecting Additional Amplifiers

To hook up surround back speakers you need to use an additional amplifier. Other than for that purpose this receiver has more than sufficient power for any home use, but it is possible to add additional amplifiers to every channel of your system. Make the connections shown below to add amplifiers to power your speakers. Before making or changing the connections, switch off the power and disconnect the power cord from the AC outlet.

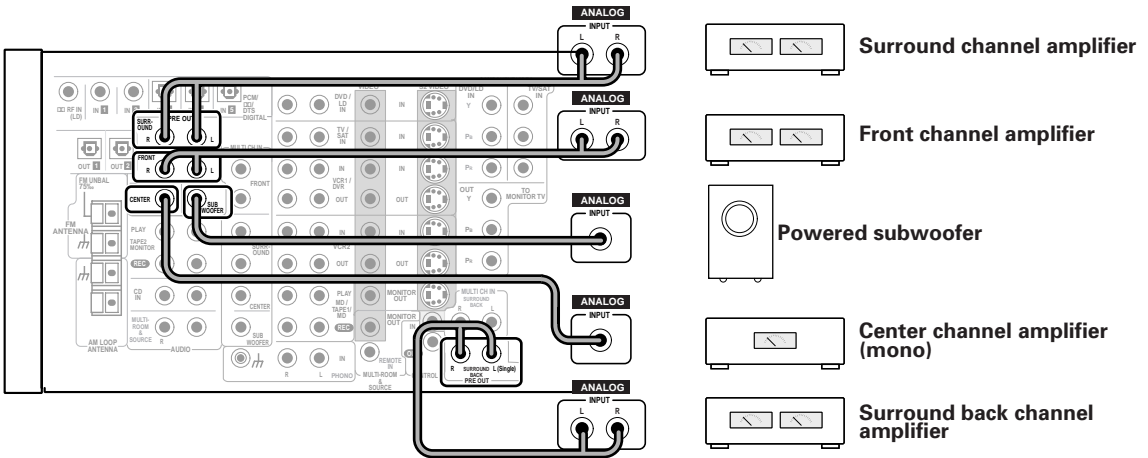

You can use the additional amplifier on the surround back channels for a single speaker as well. In this case plug the amplifier into the L (SINGLE) terminal only.

Plugging In

Up to three components can be powered from this receiver. Two of the outlets are switched, which means that power is switched on and off with the receiver. The third is unswitched, which means that power is delivered so long as the receiver is plugged in.

Before making or changing the connections, switch off the power and disconnect the power cord from the AC outlet.

After connecting all your components, plug the receiver's power cord into a standard wall power outlet.

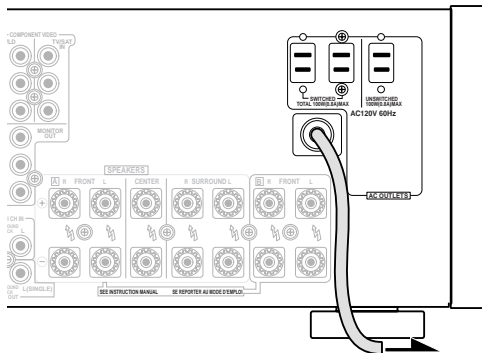

Caution !

Do not connect a monitor or TV to this unit's AC OUTLETS.

Caution!

Power consumption of any equipment connected to the **switched** power outlets should not exceed **100 W (0.8 A)**.

Power consumption of any equipment connected to the **unswitched** power outlet should not exceed **100 W (0.8 A)**.

To avoid overheating, fire risk and possible malfunction, do not connect high-wattage appliances such as heaters, irons, monitors or TV sets to this unit's AC outlets.

Disconnect the receiver from the power outlet when it's not in regular use, for example, when on vacation.

Displays & Controls

Front Panel

All the controls on the front panel are explained and/or referenced here. To open the front panel push gently on the lower third of the panel.

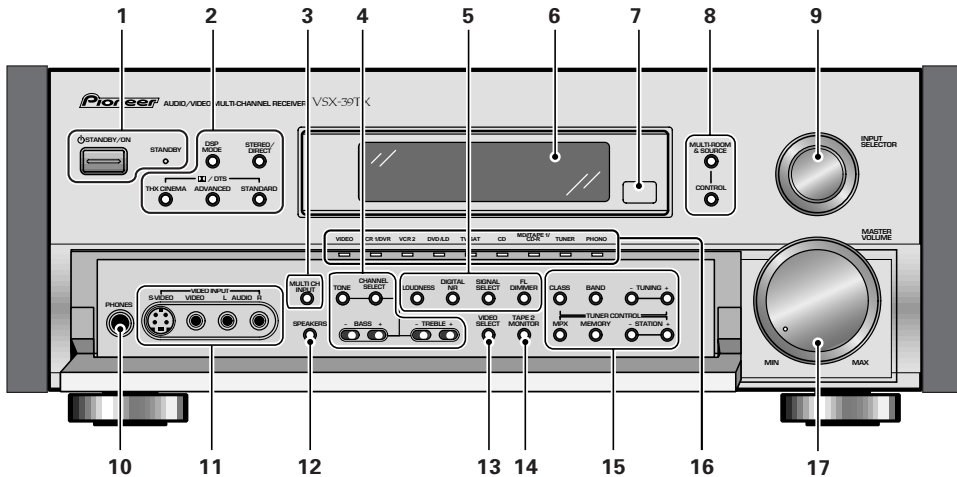

1 **STANDBY/ON button**

Press to switch the receiver ON or into STANDBY mode.

STANDBY indicator

Lights when the receiver is in STANDBY mode. (Please note that this receiver consumes a small amount of power [1.0 W] in the standby mode.)

2 **DSP MODE button (See p.45)**

Press repeatedly to select a DSP sound mode. (HALL 1, HALL 2, JAZZ, DANCE, THEATER 1, or THEATER 2, 5/7 CH STEREO). Use these modes to produce surround sound from standard (two channel) stereo sources and create different listening environments.

STEREO/DIRECT button (See p.45&53)

Switches the receiver into STEREO mode if it was in a different sound mode (like DSP mode) or toggles between DIRECT and STEREO mode. For more on STEREO mode see p.45.

DIRECT playback bypasses the tone controls, DIGITAL NR, LOUDNESS, MIDNIGHT and channel level for the most accurate reproduction of a program source.

THX CINEMA / DTS buttons (See p.43-47& 84-85)

THX CINEMA – Cycles through the THX CINEMA, THX SURROUND EX or THX AUTO sound modes. If you have THX-certified speaker setup or want to re-create a THX-style sound environment. It is also appropriate for Dolby Digital, Dolby Pro Logic, DTS sources. Those with surround back speakers can use all three THX modes, those without can only use the THX CINEMA mode.

ADVANCED – Use to select one of the four Advanced Theater modes. Use to create certain types of sound environments when listening to Dolby Digital, Dolby Pro Logic, DTS sources.

STANDARD – Use for pure decoding of multi channel sources, especially Dolby Digital, Dolby Pro Logic, DTS sources. Each press toggles between STANDARD and STANDARD 7.1 mode (for use with SURROUND BACK speakers) and STANDARD auto (the receiver chooses the appropriate STANDARD mode). Those with surround back speakers can use all three STANDARD modes, those without can only use the STANDARD mode.

3 **MULTI CH INPUT (See p.52)**

Use to hook up an external component that can decode other types of signals and input them into the VSX-39TX.

4 **TONE control buttons**

TONE button

This button has two functions. Firstly, it switches between TONE ON and TONE BYPASS, which bypasses the tone circuitry. Secondly, you need to press the button before using the CHANNEL SELECT buttons to adjust the BASS & TREBLE (cannot be used in THX or MULTI CH IN modes).

CHANNEL SELECT button

Switches the tone adjust controls between the FRONT, CENTER, SURROUND and SURROUND BACK speakers. You can then use the BASS and TREBLE controls to adjust the sound.

BASS (-/+) button (See p.51)

Use to adjust low frequencies.

TREBLE (-/+) button (See p.51)

Use to adjust the high frequencies.

5 LOUDNESS button (See p.51)

Switches the LOUDNESS mode on or off (cannot be used in THX or MULTI CH IN modes).

DIGITAL NR button (See p.50)

Switches the DIGITAL NR on or off (cannot be used in THX or MULTI CH IN modes).

SIGNAL SELECT button (See p.49)

Use to select the type of signal being input into the receiver. Press SIGNAL SELECT repeatedly to select one of the following:

ANALOG – To select an analog signal.

DIGITAL – To select a optical or coaxial digital signal.

AC-3 RF – To select an RF signal.

AUTO – This is the default. If there are analog, digital and RF signals input, the receiver automatically selects the RF signal. If there are analog and digital signals input the digital will be selected.

FL DIMMER button (See p.53)

Use to adjust the brightness of the main display.

6 Display (See p.24)

7 Remote sensor

Point the remote control toward the remote sensor to operate the receiver .

8 MULTI-ROOM & SOURCE button (See p.79-83)

Press to use the multi room feature (requires an optional PIONEER Multi-Room Remote Sensor Unit MR-100 or another IR receiver).

CONTROL button (See p.79-83): Used together with the INPUT SELECTOR to select the function or use with the MASTER VOLUME to select the volume of the MULTI ROOM system.

9 INPUT SELECTOR dial

Turn to select a source component. (You can also use to select a function in the MULTI-ROOM & SOURCE mode). The source indicators show the current component:

DVD/LD – DVD player or Laser Disc player.

TV/SAT– TV or satellite tuner.

CD – Compact Disc player.

MD/TAPE1/CD-R – Tape deck, Mini Disc recorder or CD recorder connected to MD/TAPE 1/CD-R inputs/outputs.

TUNER – The receiver's built-in tuner.

PHONO – Turntable.

VIDEO – Video camera (etc.) connected to the VIDEO INPUT on the front panel.

VCR1/DVR – Video cassette recorder connected to VCR1/DVR inputs.

VCR 2 – Video cassette recorder or other component connected to VCR 2 inputs.

10 PHONES jack

Connect headphones for private listening (no sound will be heard through the speakers)

11 VIDEO INPUT jacks (See p.15)

S-VIDEO : Video input for connecting a video camera (etc.), that has an S-Video out.

VIDEO / AUDIO (L/R) : Video input for connecting a video camera, etc. that has standard video/audio outputs.

12 SPEAKERS (A/B) button

Use to select the speaker system. A is the primary setting. It plays all speakers hooked up to the A system. A & B setting only plays the front speakers of both the A & B systems and the subwoofer. Multi channel sources will be down-mixed to these Speakers so no sound will be lost. B setting only plays the front speakers connected to the B system and multi channel sources will be down-mixed to these two speakers. The button cycles through the speaker systems as follows: A⇒B⇒A&B⇒off.

13 VIDEO SELECT button

Switches the receiver between the various types of video input.

14 TAPE 2 MONITOR button

Selects the tape deck (MD recorder, etc.) connected to the TAPE 2 MONITOR inputs/ outputs. Allows monitoring of a recording as it's being made.

15 TUNER CONTROL buttons (See p.54-57)

CLASS – Press repeatedly to switch the preset station classes.

BAND – Press to select the AM or FM band.

TUNING -/+ – Use to manually tune to radio stations.

MPX – Press to switch between auto stereo and MONO reception of FM broadcasts. When the broadcast signal is weak, selecting MONO will improve the sound quality.

MEMORY – Press to start the memorization of a preset station.

STATION -/+ – Use to choose programmed radio stations.

16 Source indicators

Shows the source currently selected.

17 MASTER VOLUME

Adjusts the overall receiver volume.

Display

All the display information is explained and/or referenced here.

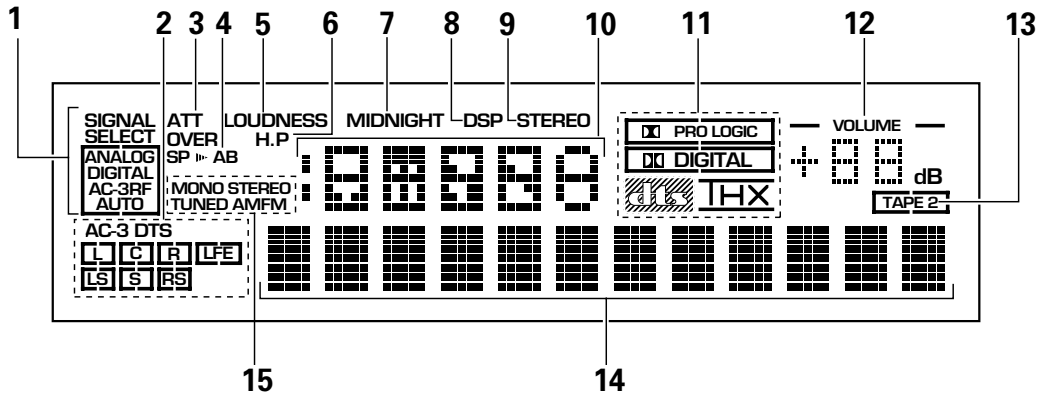

1 SIGNAL SELECT indicators

Light to indicate the input signal you selected.

ANALOG : Lights when analog signals are assigned.

DIGITAL : Lights when digital audio signals are selected.

AC-3 RF : Lights when AC-3 RF signals are assigned.

AUTO : Lights when the receiver is set to select the input signal automatically.

2 Program Format indicators

AC-3 : Lights when a source with Dolby Digital signals is played.

DTS : Lights when a source with DTS audio signals is played.

For Dolby Digital or DTS sources : These indicators change according to which channels are active in the source. When all three LS (left surround), S (surround) and RS (right surround) light at the same time it means a source with Surround EX or DTS-ES flag is being used.

L – Left front channel.

C – Center channel.

R – Right front channel.

LS – Left surround channel.

S – Surround channel (mono).

RS – Right surround channel.

LFE – Low Frequency Effects channel.

3 Analog level indicators

OVER – When the source signal is analog, this lights if the signal is in danger of distorting. Press INPUT ATT on the front panel to lower the signal level.

ATT – Lights when INPUT ATT is used to reduce the level of the analog source signal.

4 Speaker indicators

Light to indicate the current speaker system, A and/or B.

5 LOUDNESS indicator (See p.51)

Lights when the LOUDNESS mode is on.

6 H.P (headphones)

Lights when headphones are connected to the PHONES jack (speakers systems A and B both turn off automatically).

7 MIDNIGHT indicator (See p.50)

Lights when the MIDNIGHT LISTENING mode is on.

8 DSP indicator (See p.43-47, 49)

Light when a DSP or Advanced Theater modes are selected.

9 STEREO indicator

Lights when a STEREO modes are selected.

10 Radio Frequency/Function indicator

Displays the function or the frequency of the current radio station.

11 **DD / dts mode indicators**

DD DIGITAL : When the **DD** /dts mode on the receiver is on, this indicator lights to indicate playback of a Dolby Digital signal. However, **DD** PRO LOGIC lights during 2 channel playback of Dolby Digital.

DD PRO LOGIC : When the **DD**/dts mode on the receiver is on, this indicator lights during 2 channel playback.

DTS : When the **DD**/dts mode on the receiver is on, this indicator lights to indicate playback of a DTS signal.

THX: Lights when the HOME THX CINEMA mode is selected.

12 **MASTER VOLUME indication**

Displays current volume level.

13 **TAPE 2 indicator**

Lights when the TAPE 2 monitor is on.

14 **Character display**

Shows current mode, status, etc.

15 **TUNER indicators**

MONO : Lights when the tuner is set to receive FM broadcasts and when selected MPX mode.

STEREO : Lights when a FM stereo broadcast is received in the auto stereo mode.

TUNED : Lights when a broadcast is received.

AM/FM : Light to indicate the current band (FM or AM).

Remote Control

These pages describe the buttons on the remote control used to operate the receiver. Since the screen on this LCD remote control changes when you select a different function, explanations of buttons for controlling other components/functions can be found in the sections for those components/functions.

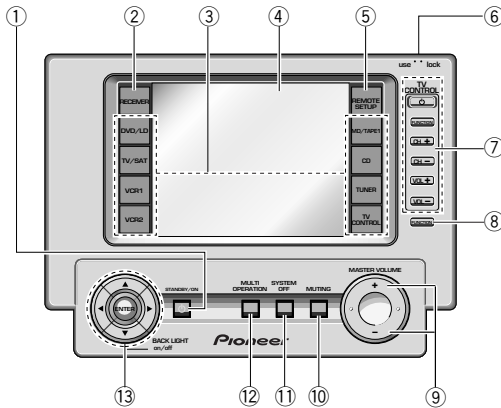

To turn on the remote control touch it anywhere on the screen

① **STANDBY/ON button**

Press to turn power of the receiver on or to STANDBY (off).

② **RECEIVER button**

Press to switch the remote control into receiver mode or to get receiver screens.

③ **Function buttons**

These buttons are the basic controls that switch the mode of the receiver and allow you to control your other components.

DVD/LD: Press to switch the remote control into DVD/LD mode.

TV/SAT: Press to switch the remote control into TV/SAT (satellite tuner) mode.

VCR 1: Press to switch the remote control into VCR 1 mode.

VCR 2: Press to switch the remote control into VCR 2 mode.

MD/TAPE 1: Press to switch the remote control into MD/TAPE 1 mode.

CD: Press to switch the remote control into CD mode.

TUNER: Press to switch the remote control into TUNER mode.

TV CONTROL: Press so that the remote control can operate the TV CONTROL commands.

④ **REMOTE CONTROL screen (See p.27-28)**

⑤ **REMOTE SETUP button.**

Use to customize the remote control functions and the remote control itself. (See "Setting Up Remote Control of Other Components" starting on p.58)

⑥ **LOCK switch**

Use to lock the remote control so it doesn't turn on by accident. For normal use keep it set in USE.

⑦ **TV CONTROL buttons**

The following buttons are used to control the TV only and can be used once they are preset to control your TV.

⑧ **STANDBY/ON :** Press to turn the power of the TV on/off.

FUNCTION : Press TV FUNC to select the TV for remote control operation.

CH +/- : Use these buttons to change the channel of the TV.

VOL +/- : Press to control the volume of the TV.

⑧ **FUNCTION button**

Press to select a source. The button will cycle through all the possible sources.

⑨ **MASTER VOLUME button**

Use to raise or lower the volume of the receiver.

⑩ **MUTING button**

Press to mute or restore the volume.

⑪ **SYSTEM OFF button (see p.76)**

This button turns off components in two ways. First, when pressed it will turn off all PIONEER components. Secondly, any component that has programmed into the SYSTEM OFF settings will be turned off.

For example : If you programmed power off in the SYSTEM OFF settings for your TV and VCR, pressing the SYSTEM OFF button will turn off these components even if they are not PIONEER products.

⑫ **MULTI OPERATION button**

Use this button to start the MULTI OPERATION mode. See p. 74-75 for how to program and use the MULTI OPERATION mode.

⑬ **▲/▼(BACK LIGHT on/off)/◀/▶/ENTER buttons**

These buttons can be used for a variety of operations. In the SYSTEM SETUP menu, the ▲/▼ buttons can be used to adjust CHANNEL DELAY or CHANNEL LEVEL. The ▲/▼ buttons, pressed simultaneously, can be used to lock or unlock a setting (see p.61). These buttons are also used to control the DVD menu for the DVD remote control screen. If the remote control is in the REMOTE SETUP mode you can use the ▼ button to adjust the BACKLIGHT. (See p.31)

Basic Receiver LCD Screens

Receiver MAIN Screen

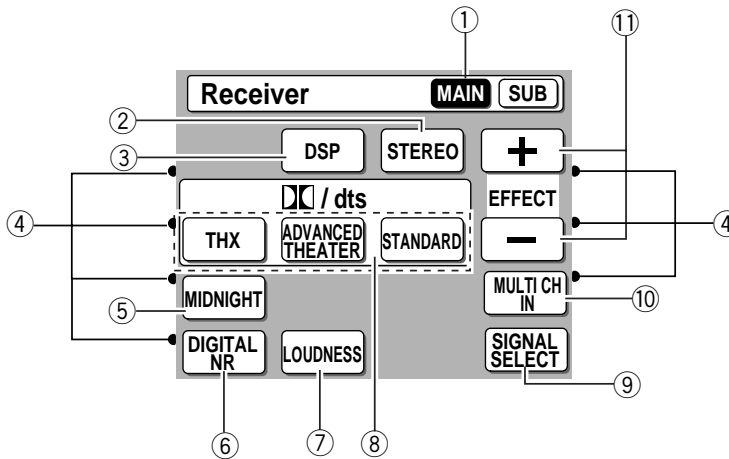

- ① **Receiver MAIN button**
Press this button to select the main receiver screen (above) when the remote control is on the sub receiver screen.
- ② **STEREO button (See p.44, 46, 48 & 53)**
Switches the receiver into STEREO mode if it was in a different sound mode (like ADVANCED THEATER or THX CINEMA) or toggles between DIRECT and STEREO mode.
- ③ **DSP button (See p.45,46)**
Press repeatedly to select a DSP sound mode.
- ④ **DIRECT FUNCTION on/off indicator (See p.78)**
These dots indicate whether the DIRECT FUNCTION is on or off for the function (DVD/LD, CD, etc.) they point to.
- ⑤ **MIDNIGHT button (See p.50)**
Switches the MIDNIGHT LISTENING mode on or off (for all modes except THX and MULTI CH IN).
- ⑥ **DIGITAL NR button (See p.50)**
Switches the DIGITAL NR on or off (for all modes except THX and MULTI CH IN).
- ⑦ **LOUDNESS button (See p.51)**
Switches the LOUDNESS mode on or off (for all modes except THX and MULTI CH IN).
- ⑧ **DOLBY DIGITAL / dts buttons (See p.43-47)**
Press these buttons to put the receiver in the selected surround sound mode. For more information on the modes see p.43-45.
- ⑨ **SIGNAL SELECT button (See p.49)**
Press SIGNAL SELECT repeatedly to select one of the following:
ANALOG : To select an analog signal.
DIGITAL : To select a digital signal (DVD/LD, TV/ SAT, CD, MD/TAPE 1, VCR 1, VCR 2).
AC-3 RF : To select an RF signal (DVD/LD, TV/ SAT, VCR 1, VCR 2).
AUTO : This is the default. If there are analog, digital and RF signals input, the receiver automatically selects the RF signal. If there are analog and digital signals input the digital will be selected.
- ⑩ **MULTI CH IN button (See p.52)**
Use to hook up an external component that can decode other types of signals and input them into the VSX-39TX.
- ⑪ **EFFECT +/- button**
Use these buttons to increase or decrease the amount of effect applied in a DSP or Advanced Theater mode. When the amount of effect is increased in a DSP/Advanced Theater mode the characteristics of that mode become stronger and more noticeable. The scale ranges from 10-90 with 70 as the default setting. First turn on the DSP/Advanced Theater mode you want (by pressing the DSP/Advanced Theater button until you get the mode) and then increase or decrease the amount of effect.

Receiver SUB Screen

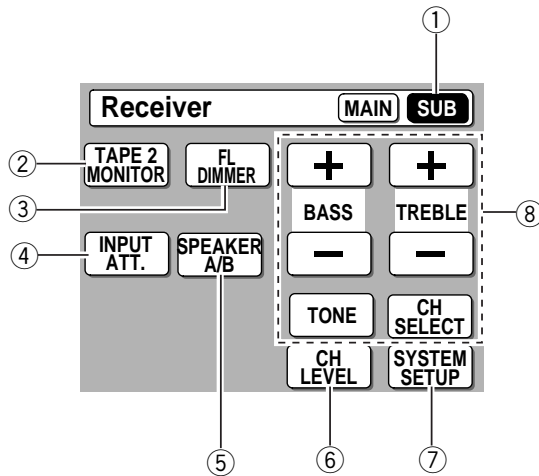

① **Receiver SUB button**

Press this button to select the sub receiver screen (above) when the remote control is on the main receiver screen.

② **TAPE 2 MONITOR button**

Selects the tape deck (or MD recorder, etc.) connected to the TAPE 2 MONITOR inputs/outputs. Allows monitoring of a recording as it's being made.

③ **FL DIMMER button (See p.53)**

Use to adjust the brightness of the main display.

④ **INPUT ATT button**

Use to lower the input level of an analog signal that is too powerful, thus causing the receiver to distort (in this case the overload indicator will be flashing furiously).

⑤ **SPEAKER A/B button**

Use to select the speaker system. A is the primary setting. It plays all speakers hooked up to the A system. A & B setting only plays the front speakers of both the A & B systems and the subwoofer. Multi channel sources will be down-mixed to these speakers so no sound will be lost. B setting only plays the front speakers connected to the B system and multi channel sources will be down-mixed to these two speakers. The button cycles through the speaker systems as follows: A⇒B⇒A&B⇒off.

⑥ **CH LEVEL button (See memo p.38)**

Use this feature to adjust the level of individual speakers during playback of a source.

⑦ **SYSTEM SET UP button**

Use to set up the speaker and sound systems. For more information see "Setting for Surround Sound" starting on p.32.

⑧ **TONE control buttons**

TONE button

This button has two functions. Firstly, it switches between TONE on and TONE BY-PASS, which bypasses the tone circuitry. Secondly, you need to press the button before using the CHANNEL SELECT buttons to adjust the BASS & TREBLE.

CH SELECT button

Switches the tone adjust controls between the FRONT, CENTER, SURROUND and SURROUND BACK speakers. You can then use the BASS and TREBLE controls to adjust the sound.

BASS & TREBLE (+/-) buttons (See p.51)

Use to adjust the high and low frequencies.

Initial Set Up

On Screen Display

There are a number of possible ways to hook up the receiver to your video components, like a DVD player, and hook up to your receiver to your TV, but some of them won't allow you to use the on-screen display of this unit. To avoid this one simply needs to follow two rules.

- ① Always use the same type of video cords to hook up your video components to the receiver as you use to hook up the receiver and your TV. For example, if you use composite video cords to hook up your DVD and the receiver, use composite video cords to hook up the receiver to your TV. If you use S video cords to hook up your DVD and the receiver, use S video cords to hook up the receiver to your TV.
- ② Always make sure your TV is set to the appropriate input channel (for example, video 1). Your TV may have a number of input channels and if you don't select the proper one you won't be able to use this receiver's on-screen display, or, in fact, see any picture from this receiver at all. If you are unsure how to choose an input channel for your TV, refer to the manual which came with your TV.

You might, for example, use both composite and S video cords to hook up your video components with this receiver and then use composite video cords to hook up this receiver to your TV. This arrangement would still NOT let you see the on screen displays from this receiver on your TV. The best idea is just to use one type of video cord for all your video component and TV hook ups.

Switching video system between PAL and NTSC

This receiver is able to use two types of video systems for its OSD (on screen display) either PAL or NTSC. If you don't match the system on the receiver with your home system no OSD will appear on your TV. **The default setting is NTSC, which is the standard in North America. If you use this system you don't need to make any settings here.** People with multi-system TVs, don't need to worry about changing the setting. If necessary, follow the instructions below to switch the type of video system.

SET
UP

1 Put the receiver in the STANDBY mode.

2 While holding down the LOUDNESS button press the STANDBY/ON button.

The video system type will change depending on the state the receiver was previously in. The new type, either PAL or NTSC, will appear in the display. It will be shown for about seven seconds and then the receiver returns to normal operating mode.

To change the video system type again repeat steps 1 and 2.

Make sure you press the LOUDNESS button, using others buttons may change this receiver's settings.

 STANDBY/ON

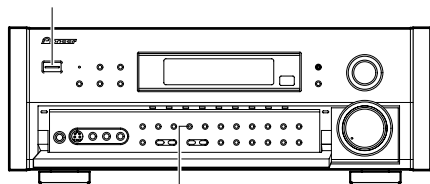

LOUDNESS



When a PAL system is selected



When an NTSC system is selected



When using the PAL setting the OSD does not get displayed in color.

Setting Up the Remote Control

Since this remote is based on LCD screens, you should try and get used to the touch-sensitive nature of the buttons as well as the way in which different screens control different operations. You can move between the different screens with the function buttons on the left and right and/or certain buttons within each screen. The BACK button will always return the remote control to the previous screen. In the explanations below you must complete the TOUCH PANEL ADJUSTMENT setup to use the remote control properly. After that you can adjust various basic settings to suit your personal preferences.

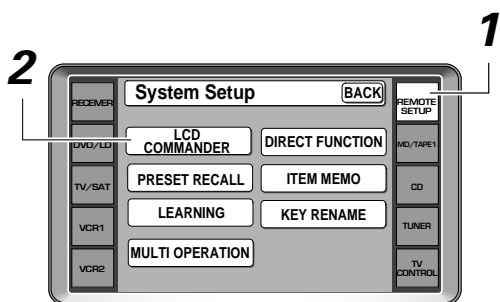

1 Press REMOTE SETUP on the remote control.

Access to the different setup modes appear on your remote control screen.

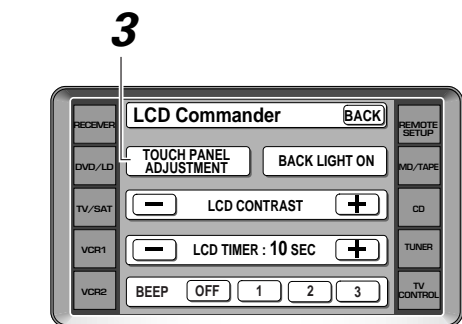

2 Press the LCD COMMANDER button.

The different types of possible adjustments will appear on the screen.

3 Since you must first align the touch panel to make sure the remote control responds properly when you touch it, press the TOUCH PANEL ADJUSTMENT button.

4 Press each cross point in the middle to align the remote control touch panel with the LCD panel underneath.

This adjustment will make sure your remote control is calibrated correctly.

When you've touched all four cross points the screen will show the word "COMPLETE" and automatically return to the LCD COMMANDER screen.

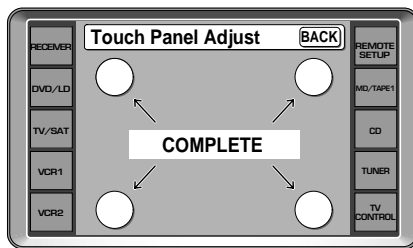
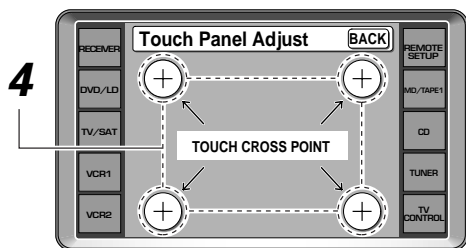

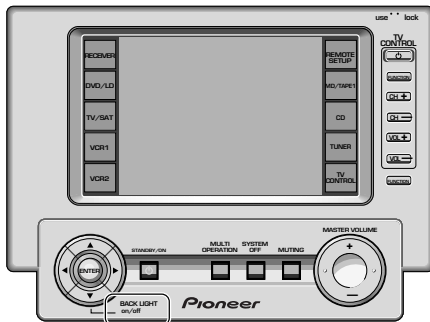

5 (BACK LIGHT)

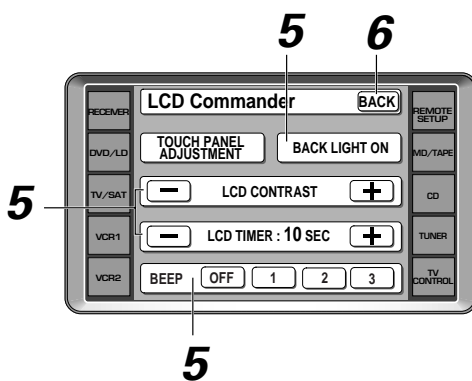

5 Decide which other adjustments you'd like to make and press those buttons. The different possibilities are:

BACKLIGHT : The backlight button let's you choose whether or not you want to have the backlight for this LCD screen on or off. If you leave it on the screen is easier to see but the remote consumes more power. In a dark room you can simply push the REMOTE SETUP button and then use the ▼ button to turn on the BACKLIGHT.

LCD CONTRAST: You can lighten or darken the contrast on the remote control screen. Use the -/+ buttons to change the contrast.

LCD TIMER: In order to save the battery a timer will automatically turn the remote control off after a set amount of time if no commands are entered. You can choose how long the idle remote control will stay on before the timer turns it off. You can set this function in a range of 5-60 seconds. The default setting is 10 seconds. Use the -/+ buttons to adjust the number of seconds for the timer setting.

(SYSTEM SETUP screens and REMOTE SETUP screens, as well as the screens within those operations, are all fixed to stay on 60 seconds. If no command is entered they will turn off after 60 seconds.)

BEEP: When you have sent a command (pushed a button) the remote control will beep once. You can choose the sound of the beep from three different possibilities here by pushing the appropriate button (1,2,3). You can also turn the beep sound off.

6 When you are finished with the adjustments you can press the BACK button repeatedly to go back to the RECEIVER screen. You can also simply push the RECEIVER button to go back to the RECEIVER MAIN screen.



You can press BACK anytime to go back a screen or repeatedly to escape this set up mode.

Setting Up for Surround Sound

To ensure the best possible surround sound, complete the following set up operations. You only need to make these settings once (unless you change the placement of your current speaker system or add new speakers, etc.). These set up operations use your TV to display the settings and choices so be sure your TV and receiver are properly hooked up.

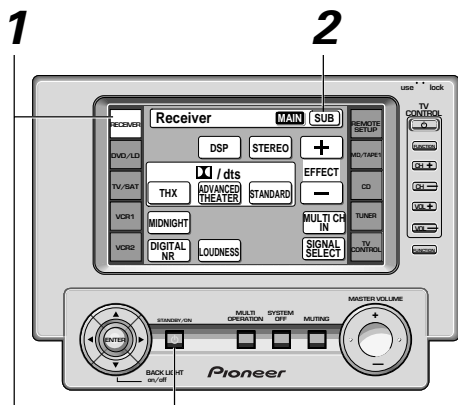

1 Turn on the receiver and your TV, press the RECEIVER on the remote control.

Make sure your TV is set to the receiver.

2 Press the SUB button on the receiver screen.

3 Press the SYSTEM SETUP button.

Access to the different set up modes appear on your remote control screen. These set up possibilities will also appear on your TV.

4 Follow the order below to set up your speakers for surround sound.

In each mode, the current settings are displayed automatically. We suggest you adjust all these settings when you first hook up the receiver. That gets them out of the way and you won't need to return to this setting mode unless you change your home set up by adding new speakers (etc.).

DIGITAL INPUT SELECT (See p.33)

In order to use your digital components you must match the numbered digital input buttons with the numbered digital jacks used by your digital components.

SPEAKER SETTING (See p.34-35)

Use to specify the type and number of speakers you connected.

CHANNEL DELAY (See p.36)

You must add distance settings to all your speakers for the most realistic surround sound. Adding a slight delay to some speakers enhances sound separation and is particularly important for achieving a surround sound effect. You need to figure out the distance from your listening position to your speakers to add the proper delay.

CHANNEL LEVEL (See p.37-38)

Use to balance the volumes of your different speakers.

CROSSOVER NETWORK (See p.39)

This feature lets you select which bass frequencies will be sent to the subwoofer or front speakers when set to large.

BASS PEAK LEVEL MANAGER (See p.40)

Dolby Digital and DTS audio sources include ultra-low bass tones. Set the bass peak level as needed to prevent the ultra-low bass tones from distorting the sound from the speakers.

DYNAMIC RANGE CONTROL (See p.41)

This feature makes possible excellent surround sound effects when listening to Dolby Digital sources at low volumes.

MULTI ROOM (See p.79-83)

You can set up this unit to power systems in different rooms.

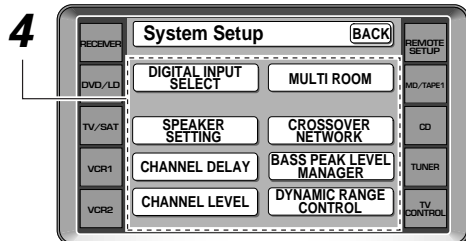
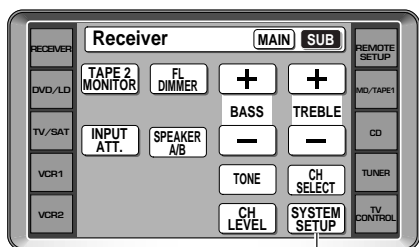

When you press SETUP OK to complete one of the settings explained on the right, a mark consisting of four curved lines appears on the top right of the remote control. This means the remote control is sending the commands to the receiver. If the receiver has gotten the commands the word "received" appears in the display on the receiver. During this process you must keep the remote control pointed at the receiver so the command can be communicated from the remote control to the receiver. To cancel press the BACK button, you will return to the SYSTEM SETUP menu.

DIGITAL INPUT SELECT

In order to be able to use your digital equipment properly you need to assign digital inputs for each of the digital components you connected. Match the DIGITAL IN buttons 1-5 with the digital jacks 1-5 in accordance with what component is hooked up to each digital jack. Check the digital terminal numbers on the back of the receiver to make certain what component is in which jack (if necessary, see p.10 for more on digital connections). Note that you can only assign a function (like DVD/LD) once after that it will disappear from the choices from which you can assign buttons. The last button, the AC-3 RF button, is specifically for a DVD/LD or LD player with an **RF** output. If you connected one of these components match this button to the component. If continuing from the previous page go to step 1. If starting fresh, complete steps 1-3 in "Setting Up for Surround Sound" (p.32) first.

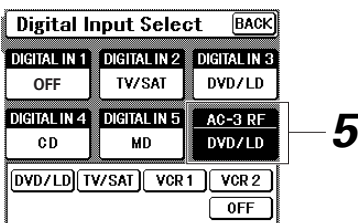
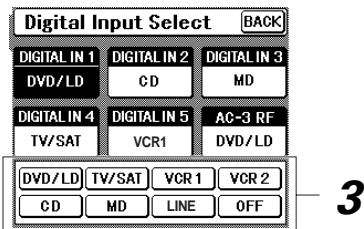
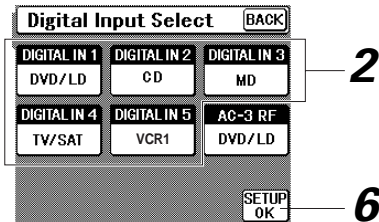
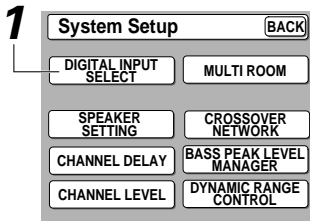

- For the DIGITAL IN 1-5 buttons you can choose between DVD/LD, CD, TV/SAT, MD/TAPE 1/CD-R, VCR 1/DVR and VCR 2 functions.
- For the AC-3 RF button you can choose between DVD/LD, TV/SAT, VCR 1/DVR and VCR 2 functions. Remember, if you have a DVD/LD player or LD player you should hook it up to the analog and digital jacks in addition to the **RF** connection described here.
- To go back without entering any of the information selected use the BACK button.

1 Press the DIGITAL INPUT SELECT button.

2 Press the DIGITAL IN button you want to assign.

3 At the bottom of the LCD screen the functions available will appear. Press the button of the function you want to assign to the selected DIGITAL INPUT button.

This procedure assigns a digital function to the DIGITAL IN. If you assign a function (for example DVD/LD) that has already been assigned to another button the new button will get the function and the old one will automatically turn to OFF. This is because one function cannot be assigned twice.

If a digital jack has nothing connected to it set the corresponding button to OFF.

4 Repeat step 2 & 3 until all the DIGITAL IN buttons correspond to the components you connected.

5 If you hooked up a component to the AC-3 RF channel use steps 2 & 3 to assign a function to it.

6 Press the SETUP OK button to return the SYSTEM SETUP mode.

Hold the remote control pointed towards the receiver until you see the "RECEIVED" display on the receiver. If "ERROR" flashes in the display, perform the setup operations from the first step again.



These settings will be displayed on your TV. (The settings pictured here are the default settings.)

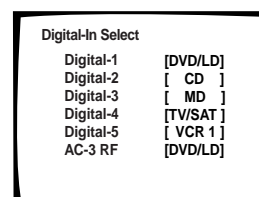

Initial Set Up

SPEAKER SETTING

The following steps show you how to select the correct set up for the type and number of speakers you connected. If continuing from DIGITAL INPUT SELECT go to step 1. If starting fresh, complete steps 1-3 on p.32 first.

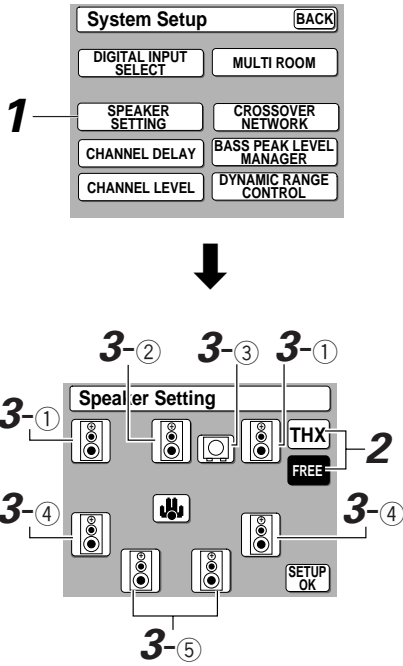

To confirm what drawings represent which speakers in the LCD display on your remote control see the diagrams below, which continue on to the next page. You can choose two, one or no SURROUND BACK speakers (and their size) by repeatedly pressing on their image in the diagram.

TWO (DOUBLE) SURROUND BACK SPEAKERS

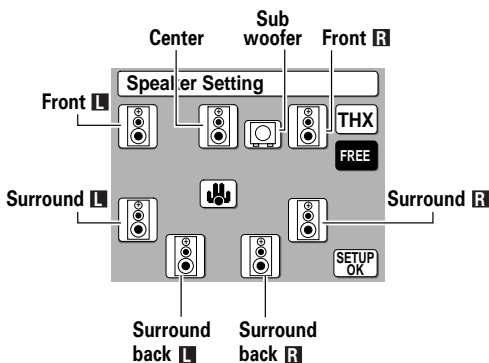

1 Press the SPEAKER SETTING button.

2 Select the THX or FREE setting.

If you connected a complete set of THX speakers

Press THX. After that you only need to select the number of SURROUND BACK speakers you have (Step 3-5 below). Press the diagram of the SURROUND BACK speakers to cycle through the three choices: one, two or none and choose number you have. Then go to step four.

If you do not have a THX speaker set up

Press FREE and follow the instructions below.

3 Specify the number and type of speakers you connected by pressing on the speakers in the diagram.

- ① Select Large (three dots) or small (two dots) for the front speakers depending on whether your front speakers can handle low bass sounds and whether or not you hooked up a subwoofer.
- ② Select or deselect center speaker depending on whether or not you hooked one up. Also choose the size, large or small.
- ③ Select or deselect subwoofer depending on whether or not you hooked one up. Also select PLUS if you have a subwoofer and want extra bass sound.
- ④ Select or deselect surround speakers depending on whether or not you hooked them up. Also choose large or small.
- ⑤ Select or deselect surround back speakers depending on whether or not you hooked them up. Also choose large or small and one or two.

Depending on your choices the sound will be routed differently. For more information see below.

FRONT (default setting is LARGE)

- Select small to send bass frequencies to the subwoofer.
- Select large if your speakers will reproduce bass frequencies effectively or if you did not connect a subwoofer.

(If you select small for the front speakers the subwoofer will automatically be switched YES. Also, the center and surround speakers cannot be set to large if the front speakers are set to small. In this case, all bass frequencies are sent to the subwoofer.)

CENTER (default setting is LARGE)

- Select large if your speaker will reproduce bass frequencies effectively.
- Select small to send bass frequencies to the other speakers or subwoofer.
- If you did not connect a center speaker, deselect it. In this case, the center channel is output from the front speakers.

ONE (SINGLE) SURROUND BACK SPEAKER

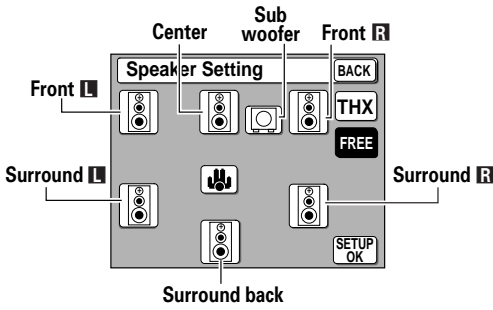

NO SURROUND BACK SPEAKERS

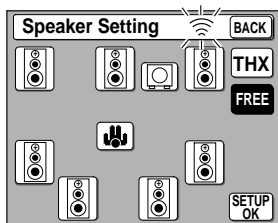
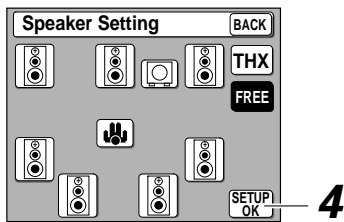
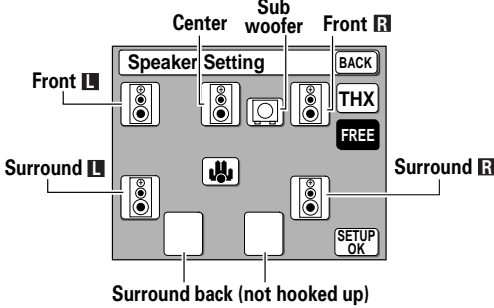

If you have a subwoofer and like lots of bass, it may seem logical to select LARGE for your FRONT speakers and leave the subwoofer selected. This may not, however, yield the best bass results. Depending on the size and shape of your room you may actually experience a decrease in the amount of bass due to what is called "low frequency cancellations." If you have a subwoofer, listen to the bass response with the FRONT speakers set to LARGE and SMALL alternatively and let your ears judge which sounds best.

If you have a subwoofer, the safest option is to route all the bass sounds to it by selecting SMALL for the FRONT speakers.

SURROUND (default setting is LARGE)

- Select large if your speakers will reproduce bass frequencies effectively.
- Select small to send bass frequencies to the other speakers or subwoofer.
- If you did not connect surround speakers deselect them. In this case, the sound of the surround channels is output from the front and center speakers.
- Remember, If you select small for the front speakers, the SURROUND and SURROUND BACK speakers can only be set to SMALL.

SURROUND BACK (default setting is LARGE X2)

NOTE: In order to use SURROUND BACK speakers you need to hook them up through an external amplifier (see p.21 for more on this).

- Select the number of SURROUND BACK speakers you have. You can choose one speaker, two or none.
- Select large if your speakers will reproduce bass frequencies effectively.
- Select small to send bass frequencies to the other speakers or subwoofer.
- If you did not connect surround back speakers deselect them. In this case the boxes in the diagram will appear empty, as shown on the left.
- If the FRONT speakers or the SURROUND speakers are set to SMALL, the SURROUND BACK speakers will automatically be set to SMALL.
- If you choose THX in step 2 then the SURROUND BACK speakers can only be set to small (or off).

SUBWOOFER (default setting is YES)

- Leave it selected if you connected a subwoofer.
- If you did not connect a subwoofer deselect it. In this case, the bass frequencies are output from the front or surround speakers.
- Choose the PLUS setting if you want stronger reproduction of deep bass sounds.
- If you select PLUS the bass frequencies that would normally come out the front and center speakers are all routed to the subwoofer.
- If you selected SMALL for the FRONT speakers the subwoofer will automatically be set to on (you won't be able to choose off or PLUS).

4 Press the SETUP OK button to return to the SYSTEM SETUP MENU.

Hold the remote control pointed towards the receiver until you see the "RECEIVED" display on the receiver. If "ERROR" flashes in the display, perform the setup operations from the first step again.



The settings you chose will be displayed on your TV.

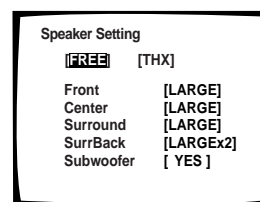

Next, proceed to CHANNEL DELAY below.

If you want to change a setting before proceeding simply press the button of the speaker you want to change.

Initial Set Up

CHANNEL DELAY

Adding a slight delay to some speakers is necessary to achieve a surround sound effect. You need to figure out the distance from your listening position to your speakers to add the proper delay. The following steps show you how to set the delay time for each channel by specifying the distances from your listening position to each speaker. Once you specify the speaker distances, the receiver calculates the correct delay times automatically. If continuing from SPEAKER SETTING go to step 1. If starting fresh, complete steps 1-3 in "Setting Up for Surround Sound" (p.32) first.

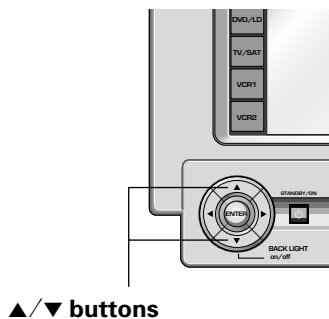
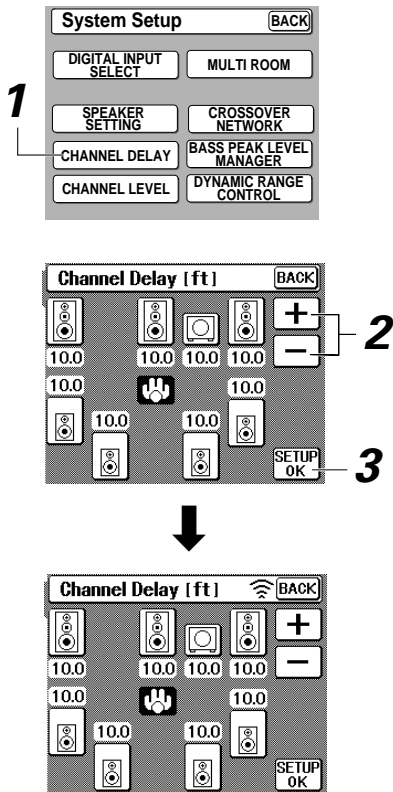

1 Press the CHANNEL DELAY button.

The CHANNEL DELAY speaker settings will appear on your remote control screen.

2 Select each speaker by pressing its button and use the +/- (or ▲/▼) buttons to add or subtract the distance in feet that the speaker is from your normal listening position.

Adjust the speaker distance in half foot increments from 0.5 to 45 feet (1 foot equals approximately 0.3 meters). The default setting is 10 ft.

3 Press the SETUP OK button to return to the SYSTEM SETUP MENU.

Hold the remote control pointed towards the receiver until you see the "RECEIVED" display on the receiver. If "ERROR" flashes in the display, perform the setup operations from the first step again.



These settings will be displayed on your TV.

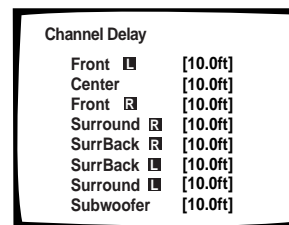

Next, proceed to CHANNEL LEVEL below.
If you want to change a setting before proceeding
Start over from step one.



You can use the ▲/▼ buttons at the bottom of the remote control instead of the +/- buttons.

CHANNEL LEVEL

The following steps show you how to balance the sound output level of your speakers. Proper speaker balance is essential for obtaining high quality surround sound. If continuing from CHANNEL DELAY go to step 1. If starting fresh, complete steps 1-3 in "Setting Up for Surround Sound" (p.32) first.

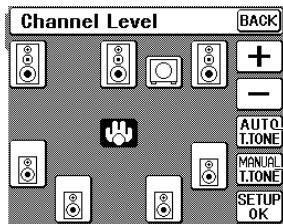
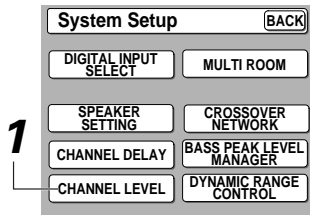

1 Press the CHANNEL LEVEL button.

The CHANNEL LEVEL settings will appear on your remote control screen.

NOTE : Be prepared! The test tone is output at a high volume level.

MASTER VOLUME rotates to the reference position (0 dB) and the display on the receiver flashes TEST TONE. After a few seconds the test tone is output.

These settings will be displayed on your TV.

2 Select a test tone mode by pressing one of the TEST TONE buttons. Output the TEST TONE.



AUTO (automatic TEST TONE)

This mode switches the test tone between each speaker automatically. The automatic test tone is output in the following order :

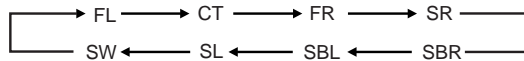

MANUAL (manual TEST TONE)

This mode lets you switch the test tone between each speaker manually.

FL	CT	FR
0.0 dB	0.0 dB	0.0 dB
SL	SW	SR
0.0 dB	0.0 dB	0.0 dB
SBL	0.0 dB	SBR 0.0 dB

Any time you want to exit the process

Press SETUP OK.



- Be careful, if you touch one of the speaker buttons by accident the TEST TONE will automatically sound from each speaker.
- If your subwoofer has a volume control, set it to the middle position before doing these operations.
- A test tone will be output from the SURROUND BACK speakers but your external amplifier must be turned up at least a little in order to hear it. Be careful that it is not turned up too much because the test tone volume is quite loud.

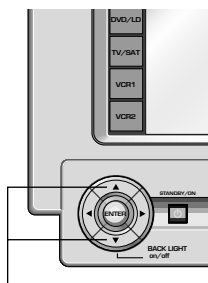
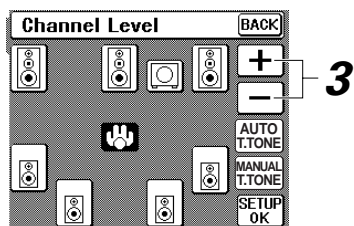

▲/▼ buttons

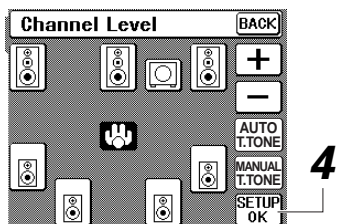

3 Using the remote control display, follow the instructions below to adjust the speaker levels so that you hear the test tone at the same volume from each speaker when seated in your normal listening position.

NOTE : The volume of the subwoofer tends to sound lower than it actually is. You may need to adjust the level after testing with an actual soundtrack.

In AUTO mode

- ① Use the +/- (or ▲/▼) buttons to adjust the level of the speaker outputting the test tone. The tone will automatically switch between speakers after sounding for 2-3 seconds.
- ② Adjust the level of all speakers.

In MANUAL mode

- ① Use the +/- (or ▲/▼) buttons to adjust the level of the first (the front left) speaker.
- ② Press the button on the touch panel for the next speaker.
- ③ Repeat ① and ② for each speaker.

If you are using a Sound Pressure Level (SPL) meter

Take the readings from your main listening position and adjust the level of each speaker to 75 dB SPL (C-weighted/slow mode).



You can use the ▲/▼ buttons at the bottom of the remote control instead of the +/- buttons.

4 When all the speaker levels have been set, press SETUP OK to return to the SYSTEM SETUP MENU.

The display on the receiver will say RESUME and the MASTER VOLUME will return to its original position.



Next, proceed to CROSSOVER NETWORK below.



Note that it is also possible to set channel levels temporarily. Then follow the same procedure as explained on this page. This function is designed to be used when you want to change the levels temporarily to raise the level of one channel. Using this method you can set speaker levels in different modes, such as, STEREO, and each DSP mode, independently. You should return the settings to their original state when done. Doing the set up procedures on this page will erase any temporary/independent level settings that have been made.

CROSSOVER NETWORK

The following steps show you how to adjust the crossover network. The crossover network is the frequency at which the system divides the signal and sends the different parts (high, mid, low) to different speakers. Speaking precisely, this setting sets the cutoff point for the bass frequencies rerouted from your SMALL speakers to your subwoofer or speaker set to LARGE. If continuing from CHANNEL LEVEL go to step 1. If starting fresh, complete steps 1-3 in "Setting Up for Surround Sound" (p.32) first.

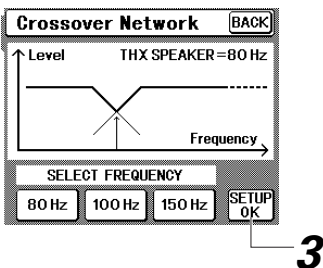
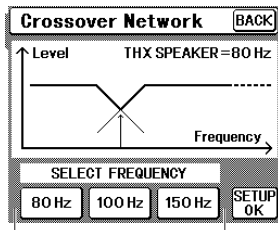
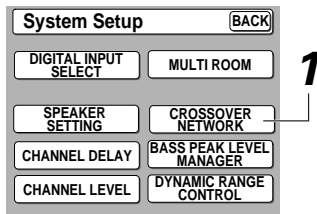

1 Press the **CROSSOVER NETWORK** button.

2 Choose a crossover frequency.

Setting speakers to SMALL in SPEAKER SETTING sends the respective channel's bass frequencies to the subwoofer or the speakers you have selected as LARGE. This function lets you determine which frequencies will be sent to the subwoofer or LARGE speakers. Press 80 Hz, 100 Hz, or 150 Hz. The default setting is 80Hz.

80 Hz

Sends bass frequencies below 80 Hz to the subwoofer (or LARGE speakers).

100 Hz

Sends bass frequencies below 100 Hz to the subwoofer (or LARGE speakers).

150 Hz

Sends bass frequencies below 150 Hz to the subwoofer (or LARGE speakers).

As noted on the LCD screen the THX setting is 80. Select this setting if you have THX approved SMALL speakers.

Experiment with the different settings to see which sounds best to you.

3 Press the **SETUP OK** button to return to the **SYSTEM SETUP MENU**.

The display on the receiver reads RECEIVED. If "ERROR" flashes in the display, perform the setup operations from the first step again.



This information will be displayed on your TV.

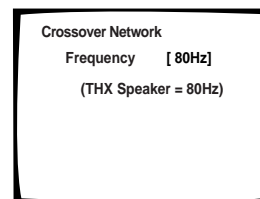

Next, proceed to BASS PEAK LEVEL MANAGER below.

If you want to change a setting before proceeding
Start over from step one.

Initial Set Up

BASS PEAK LEVEL MANAGER

The LFE (Low Frequency Effect) channel in Dolby Digital, DTS program sources can produce heavily concentrated ultra-low bass tones that may exceed the capabilities of your speaker system. The following steps show you how to set the peak level for the ultra-low bass (LFE) channel. If continuing from CROSSOVER NETWORK go to step 1. If starting fresh, complete steps 1-3 in "Setting Up for Surround Sound" (p.32) first.

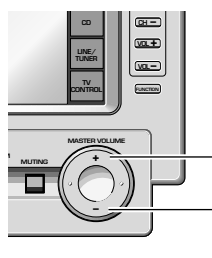
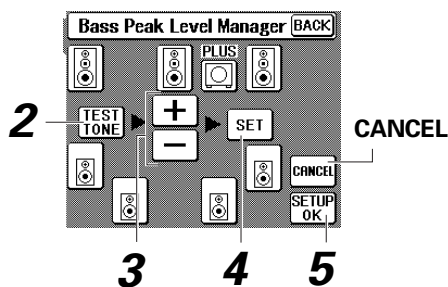
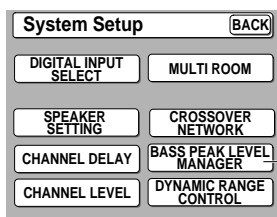

MASTER VOLUME +/-



If you press CANCEL no settings are input to the receiver but the screen remains on the remote control. To escape the screen you must press SETUP OK.

1 Press the BASS PEAK LEVEL MANAGER button.

2 Press the TEST TONE button.

The MASTER VOLUME rotates to MIN (----dB).



A test tone will sound or not depending on which speakers you have selected. If subwoofer is YES (or on PLUS) the test tone will only sound from the subwoofer. If the subwoofer is off and the front and surround speakers are set to large, front and surround speakers will sound the test tone.

3 Use the +/- buttons (or the MASTER VOLUME +/- on the bottom right of the remote control or the MASTER VOLUME on the front panel) to specify the bass peak level.

- ① Raise the level gradually.
- ② Set the bass peak level at the point just before the tone starts to distort.

4 Press the SET button to input the level.

The display on the receiver will say RESUME and the MASTER VOLUME will return to its original position.



5 Press the SETUP OK button.

You may need to experiment with different Dolby Digital sources before you can get the BASS PEAK LEVEL set correctly.

If you want to change a setting before proceeding
Start over from step one.

DYNAMIC RANGE CONTROL

This feature makes it possible to enjoy full surround sound effects on Dolby Digital sources even at low volumes. It does this by compressing the dynamic range. Dynamic range is the difference between the loudest and the softest sounds in any given signal. Compressing the range plays sounds so the quieter ones are audible and the louder ones don't get distorted or become overpowering. This feature only applies to Dolby Digital sources but the MIDNIGHT LISTENING mode (explained on p.40) accomplishes the same end for a variety of sources. If continuing from BASS PEAK LEVEL MANAGER go to step 1. If starting fresh, complete steps 1-3 in "Setting Up for Surround Sound" (p.32) first.

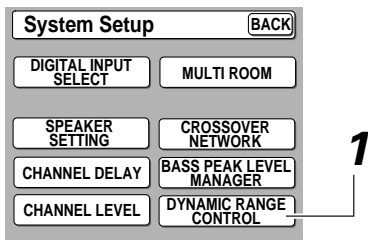

1 Press the DYNAMIC RANGE CONTROL button.

2 Choose the amount of DYNAMIC RANGE CONTROL, OFF, MID or MAX, you want.

The default setting is OFF.

3 Press the SETUP OK button.

Hold the remote control pointed towards the receiver until you see the "RECEIVED" display on the receiver. If "ERROR" flashes in the display, perform the setup operations from the first step again.



This information will be displayed on your TV.

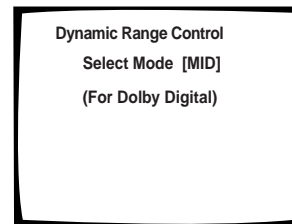
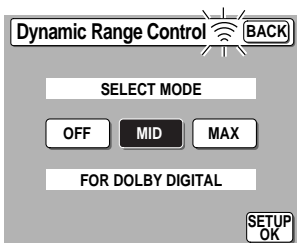
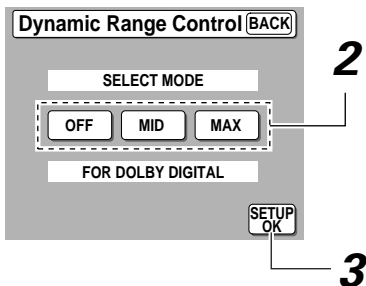

If you want to change a setting before proceeding
Start over from step one.

You may need to experiment with different Dolby Digital sources before you can use the DYNAMIC RANGE CONTROL setting to suit your low volume listening needs.



If you are listening at loud volumes we recommend turning the Dynamic Range Control OFF.

DUAL MONO SETTING

The dual mono setting can only be used when listening to Dolby Digital discs that have dual mono software encoded in them. Dual mono software usually is used to put two different soundtracks on one DVD. With this setting you can choose which channel in the dual mono setting you want to listen to. Thus, it is useful for soundtracks that have one language on one channel and a different language on the other. Remember this setting is only applicable if you are using Dolby Digital software with dual mono and want to isolate one of the channels therein. Otherwise, just ignore this function.

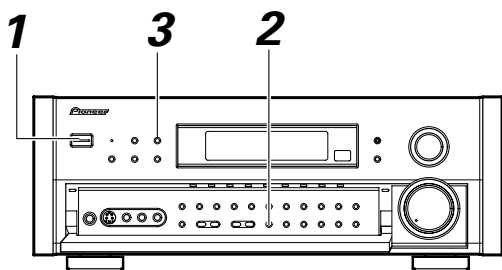

1 Put the receiver in STANDBY mode.

2 While holding down the VIDEO SELECT button press the  STANDBY/ON button on the front panel.

3 You will see DUAL in the display for about five seconds. During this time use the STEREO/DIRECT button to cycle through the different DUAL MONO settings to find the one you want.

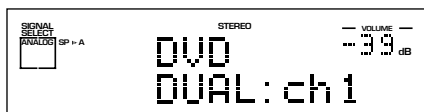

DUAL ch1 setting

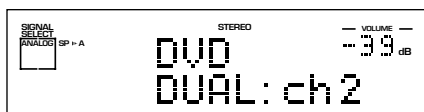

DUAL ch2 setting



DUAL ch1/ch2 setting



When DUAL MONO is playing with ch 1 selected the L will light. When playing with ch 2 selected the R will light. When playing with ch 1/2 selected the L and R will light.

The different settings are: DUAL ch1, where you only hear channel 1; DUAL ch2, where you only hear channel 2; and DUAL ch1/ch2, where you hear both channels, but independently from different speakers.

The default setting is DUAL ch1.

Basic Playback

Sound Modes

The five sound modes on the receiver are explained here. These can be turned on from the front panel or from the RECEIVER MAIN SCREEN on the remote control.

There are three cinema modes: STANDARD, HOME THX CINEMA, and ADVANCED THEATER. These are designed to be used with multi channel surround sound audio/visual sources (like DVDs and LDs). Intrinsic to home theater, these modes can deliver realistic and powerful surround sound that recreates the movie theater experience. You may need to experiment with them to see which settings suit your home system and personal tastes.

The DSP and STEREO modes are designed to be used with music sources but some DSP modes are also suited for film soundtracks. Again, try different settings with various soundtracks to see which you like.

You must choose one of the three cinema modes or the DSP mode in order to get surround sound. In STEREO mode only the front two speakers, and sometimes the subwoofer (if you have one), are used.

STANDARD modes

This mode is for pure decoding of Dolby Digital, Dolby Pro Logic and DTS sources. No special effects are added. It is good for enjoying regular movies/videos that have been recorded in Dolby Digital, Dolby Pro Logic, DTS. STANDARD 7.1 is also the basic mode for enjoying sources with SURROUND BACK channels. For more detailed information see p.85. You will only be able to access the second two modes if you have hooked up SURROUND BACK speakers(s). For more detailed information see p.19,21,34-35. The display will show you what kind of source (Dolby Digital, DTS, etc.) is being played.

STANDARD

Use this mode with sources that do not have SURROUND BACK channels. If you don't have SURROUND BACK speaker(s) switched on (see p.34-35) this is the only STANDARD mode you will be able to select on the receiver.

STANDARD 7.1

This mode is best for sources with SURROUND BACK channels. You will only be able to access this mode if you have set the SURROUND BACK speakers in the SPEAKER SETTING procedure (see p.34-35). Also, this mode will play 5.1 channels sources and other sources through all the speakers you have hooked up, routing some of the sound into your SURROUND BACK channel or channels. STANDARD 7.1 will appear in the display even if you only have one SURROUND BACK speaker hooked up. The display will change according to the source played.

STANDARD AUTO

In this mode the receiver will automatically select the appropriate STANDARD mode and use it to play the soundtrack. You will only be able to access this mode if you have set the SURROUND BACK speakers(s) in the SPEAKER SETTING procedure (see p.34-35). If the source has a Surround EX marker then the receiver will automatically go into STANDARD 7.1 mode. This mode is best if you are unsure which of the above STANDARD modes to use. The display will change according to the source played.

Basic Playback

HOME THX CINEMA modes

THX is a set of technical standards created by Lucasfilm, Ltd. These standards were designed to emulate a film sound stage and thus reproduce, with the greatest possible accuracy, the soundtrack intended by the filmmakers. To get THX sound use one the three modes explained below. You will only be able to access the second two modes if you have hooked up SURROUND BACK speakers. For more detailed information see p.19,21,34-35. This mode is best if you are unsure which of the above THX modes to use. The display will show you what kind of source (Dolby Digital, DTS, etc.) is being played.

THX CINEMA

Use this mode to get THX sound with sources that do not have SURROUND BACK channels. If you don't have SURROUND BACK speaker(s) switched on (see p.34-35.) this is the only THX mode you will be able to select on the receiver.

THX SURROUND EX

This mode is specifically for using your SURROUND BACK channels with either SURROUND EX sources or 5.1 channel sources. You will only be able to access this mode if you have set the SURROUND BACK speakers in the SPEAKER SETTING procedure (see p.34-35). If the source you are using is a 5.1 source then this mode will route some of the sound to the SURROUND BACK channel(s). If the source you are using does not have a SURROUND EX marker or is not a 5.1 source then the display will automatically change to THX CINEMA.

THX AUTO

In this mode the receiver will automatically select the appropriate THX mode and use it to play the soundtrack. You will only be able to access this mode if you have set the SURROUND BACK speakers(s) in the SPEAKER SETUP procedure (see p.34-35). If the source has a Surround EX marker then the receiver will automatically go into THX SURROUND EX mode. This mode is best if you are unsure which of the above THX modes to use.

ADVANCED THEATER modes

The Advanced Theater mode is a newly designed system for enhancing movie soundtracks and other audio-visual sources. It incorporates the use of DTS as well as Dolby Digital into its sound processing. These functions switch on automatically when the source you are playing is encoded with DTS or Dolby Digital. There are four Advanced Theater settings that use DSP (Digital Signal Processing) to create different types of sound environments. If you have SURROUND BACK speakers or (even just one) speaker switched on (see p.34-35) then 7.1 will appear after the name of all of these modes in the display on the receiver. The display will show you what kind of source (Dolby Digital, DTS, etc.) is being played.

MUSICAL

This mode is primarily for music and adds a spacious feeling to the sound. A long delay time of reflected sounds, provides resonant tones which emulate a concert hall.

DRAMA

This mode is designed for movies with a lot of dialog. The elements of dialog are enhanced, making the characters seem more real. The mode also compresses the dynamic range somewhat so loud sounds do not overpower softer ones (compare this with the MIDNIGHT LISTENING mode explained on p.50).

ACTION

This mode is designed for action movies, which generally use lots of sound effects. The mode enriches the sound to make it more realistic and extends the parameters to pick up high and low sound effects.

5/7-D THEATER

This mode is especially designed to give sound depth to stereo sources. The overall effect builds a dynamic and broad sound space, allowing two-channel (stereo) signals to faithfully imitate a five speaker sound. The mode should be used in conjunction with Dolby Pro Logic for sources bearing the

 mark.



When a Dolby Digital soundtrack is played back the Dialog Normalization function of the receiver activates automatically. Dialog Normalization is a Dolby Digital function that establishes the average dialog level for the program source being played. If the receiver's level does not match the average dialog level, first you see "DIAL NORM" flash in the receiver's display and next "OFFSET +4 dB" (as an example) will appear. In this example, the number +4 dB is the difference between the receiver's gain structure and the Dolby Digital average dialog level. To match the average dialog level, subtract or add the OFFSET level. For example, if the OFFSET level is +4 dB, the amplifier's output is 4 dB over the average recorded level.

DSP modes

The DSP (Digital Signal Processing) modes allow you to transform your living room into a variety of different sonic environments when playing either two-channel or multi-channel sources. If you have SURROUND BACK speakers(s) switched on (see p.34-35) then 7.1 will appear after the name of all of these modes in the display on the receiver.

HALL 1

Simulates the acoustic effects of a large concert hall. Suitable for classical music. A long delay time of reflected sounds, coupled with reverb effects, let the listener enjoy the dynamic and rich sounds characteristic of concert halls and powerful orchestral performances.

HALL 2

Simulates the acoustic environment of a very resonant concert hall. Rich reverberation and a full sound create the impression of a lively performance space.

JAZZ

Simulates the acoustic effects of a jazz club. Reflected sound is virtually below 100 msec so that the listener can enjoy a live band effect.

DANCE

Simulates the acoustic effects of a dance club. Features a strong bass sound.

Reflected sound delay time is virtually below 50 msec, for the listener to enjoy the visceral power of dance music.

THEATER 1

Reproduces theater sound field effects without losing the localization of each channel. Theater effects can be enjoyed without losing Dolby Digital/ Pro Logic effects when used in combination those formats (with movies bearing the  DOLBY SURROUND trademark).

THEATER 2

Simulates the acoustic environment of a theater while maintaining proper localization of each channel.

5/7CH STEREO

Simulates the acoustic environment of a regular stereo while using all the speakers in the system to induce a rich, all-around sound. If you have SURROUND BACK speakers switched on (see p. 34-35) then the name of this mode will be 7CH STEREO in the display on the receiver. If the SURROUND BACK speakers are switched off, then the mode will appear as 5CH STEREO.

STEREO mode

Use the STEREO mode to enjoy standard (two-channel) stereo sound from the front left and right speakers. This mode is most like the sound reproduction you would get from a regular stereo receiver or amplifier that is not equipped to handle A/V formats as this one is. You might want to use this mode for listening to regular music sources (like CDs) but remember, you will only get sound from your front two speakers (and possibly your subwoofer).

Selecting a Sound Mode

To ensure the best possible surround sound, be sure to complete the set up procedures described in "Setting Up for Surround Sound" (starting on page 32) before using the sound modes. This is particularly important when using the  (Dolby) Digital or DTS sources. When using the sound modes, using SPEAKERS A will give the best results. If you use SPEAKERS B the sound will be down mixed to the two front B speakers and the surround sound effect will be lost.

Using surround sound

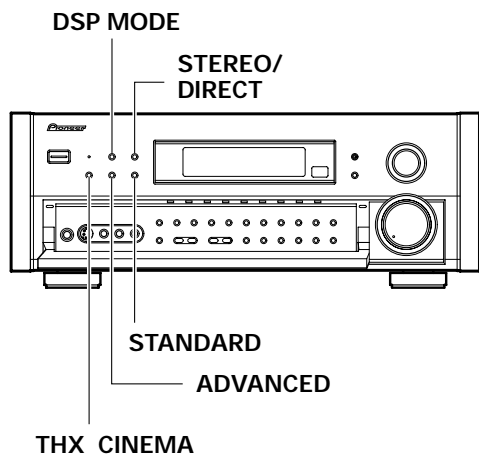
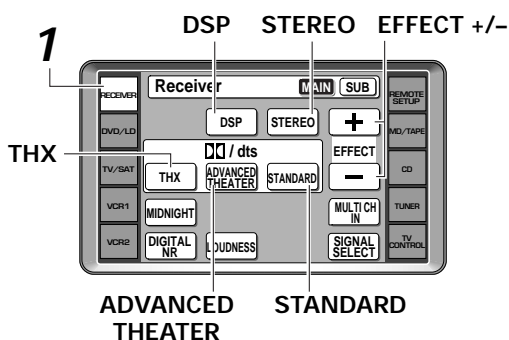

1 Press RECEIVER.

This sets the remote to select the sound mode.
(You can skip this step when using the controls on the receiver.)

2 Select the sound mode.

- For STANDARD → Press STANDARD
Each press changes the STANDARD mode as follows:

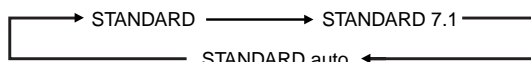

- For HOME THX CINEMA → Press THX (or THX CINEMA on the front panel)
Each press changes the THX mode as follows:

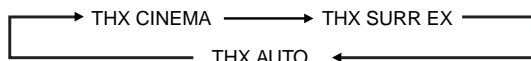

- For ADVANCED THEATER → Press ADVANCED THEATER (or ADVANCED on the front panel)
Each press changes the ADVANCED THEATER mode as follows:

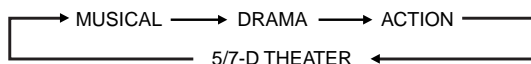

- For DSP modes → Press DSP (DSP MODE) repeatedly
Each press changes the DSP mode as follows:

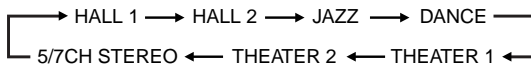

- For STEREO → Press STEREO (STEREO/DIRECT)
Each press changes the STEREO mode as follows:

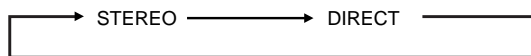

- If you have SURROUND BACK speakers switched on (see p.34-35) then 7-D THEATER and 7CH STEREO will appear as such in the display on the receiver. If these speakers are not switched on the above two modes will appear as 5-D THEATER and 5CH STEREO.
- The effects of ADVANCED THEATER mode can be adjusted in the range of 10 to 90 by pressing EFFECT +/- (The default setting is 70). Also, the effect level can be set in each ADVANCED THEATER mode by pressing the EFFECT(+/-) button.
- The amount of effect of each DSP mode can be adjusted in the range of 10 to 90 (the default setting value is 70) by pressing EFFECT +/-.
- 5/7CH STEREO modes cannot be changed.

Playing Sources with Dolby Digital or DTS Sound

The following instructions show you how to play Dolby Digital or DTS sound sources with the VSX-39TX.

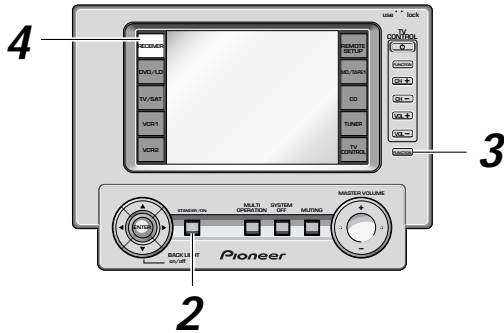

1 Turn on the power of the playback component.

2 Press the STANDBY/ON button to turn on the receiver.

Be sure that the standby indicator turns off on the front panel.

STANDBY indicator

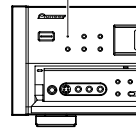

3 Press the FUNCTION on the remote control to select the source you want to playback.

Alternatively, Use the INPUT SELECTOR on the front panel.

The FUNCTION button cycles through the sources in the following order:

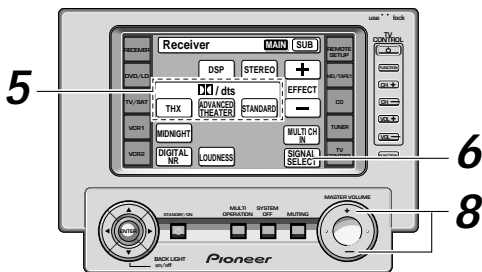

4 Press the RECEIVER.

The RECEIVER MAIN SCREEN appears on the remote.

5 Choose a / DTS mode by pressing THX, ADVANCED THEATER or STANDARD.

You need to choose one of the modes to get surround sound. For more see "Sound Modes," on p.43-45.

6 Press the SIGNAL SELECT button to the source component (setting the switch to AUTO assures the proper signal will be selected).

(See "Switching ANALOG/DIGITAL signal input" on p.49.)

7 Start playback of the component you selected in step 1.

8 Adjust the volume by using the MASTER VOLUME buttons on the remote control or the MASTER VOLUME on the front panel.

Return to the RECEIVER screens (by pressing to RECEIVER button and SUB, if needed) to make other sound adjustments like bass/treble, loudness etc.

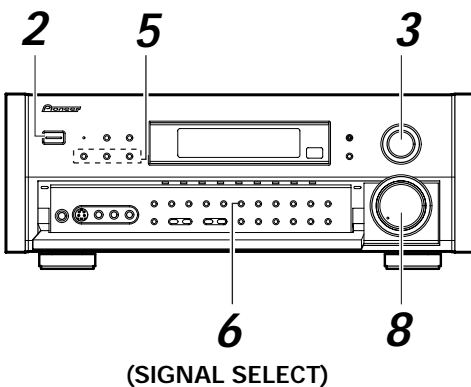

- We recommend using different modes for different types of DTS material. For watching movies, the STANDARD, THX or ADVANCED THEATER setting should provide the best results. For listening to music, the STANDARD, DIRECT, STEREO, or DSP modes should serve the listener best.
- Make sure you connect your DVD/LD or LD players using the 2 RF jack. If your player has an 2 RF output this will ensure you can use all LDs. Refer to p.14.

Playing Sources with Stereo Sound

The following instructions show you how to play audio or audio-visual sources with the VSX-39TX.



If the TAPE 2 indicator is visible in the display, it means the TAPE 2 MONITOR is on. Press TAPE 2 MONITOR on the front panel to turn it off unless you want to listen to TAPE 2.

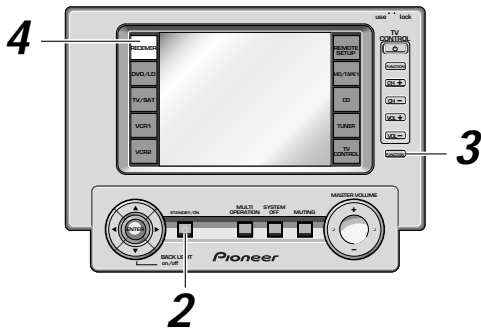

1 Turn on the power of the playback component.

2 Press the STANDBY/ON button to turn on the receiver.

Be sure that the standby indicator turns off on the front panel.

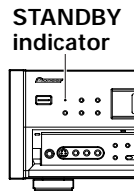

3 Press the FUNCTION on the remote control to select the source you want to playback.

Alternatively, Use the INPUT SELECTOR on the front panel.

The FUNCTION button cycles through the sources in the following order:

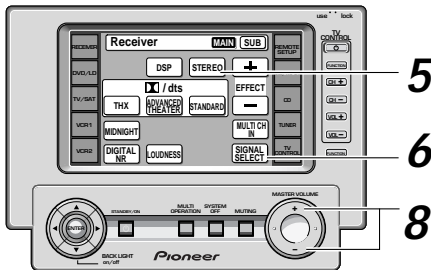

4 Press the RECEIVER.

The RECEIVER MAIN SCREEN appears on the remote.

5 Press the STEREO button to select the stereo mode.

The STEREO indicator lights on the display.

6 Press SIGNAL SELECT to select the input signal corresponding to the source component (setting the switch to AUTO assures the proper signal will be selected).

(See "Switching ANALOG/DIGITAL Signal Input" on the next page.)

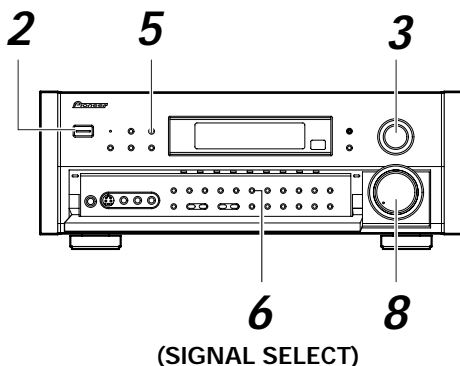

7 Start playback of the component you selected in step 1.

8 Adjust the volume by using the MASTER VOLUME buttons on the remote control or the MASTER VOLUME on the front panel.

Return to the RECEIVER screens (by pressing to RECEIVER button and SUB, if needed) to make other sound adjustments like bass/treble, loudness etc.



If you are not able to get sound from the receiver the problem may well lie with the SIGNAL SELECT switch. You need to make sure the input is set to the appropriate ANALOG or DIGITAL setting. Refer to page 49 for more on this.

Switching ANALOG/DIGITAL Signal Input

This button selects the type of input, ANALOG, DIGITAL or **RF**, sent to the receiver. You need to take special care to switch to the appropriate input when necessary. For example, the switch would have to be on DIGITAL to hear DOLBY DIGITAL or DTS surround sound material but it would have to be on analog to record from the ANALOG out jacks on the receiver. The default setting is AUTO which chooses digital when all three are available but goes with whatever is available if it is the only choice.

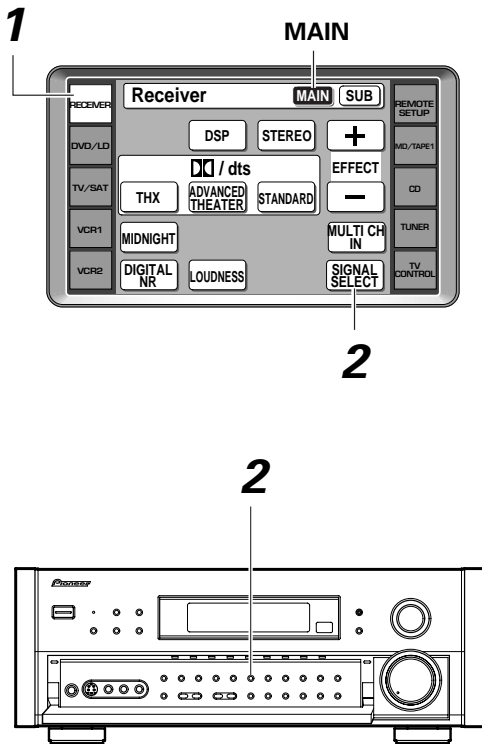

1 Press the RECEIVER.

2 Press the SIGNAL SELECT button to select the input signal corresponding to the format of the source component.

Each press switches the signal in the order below:

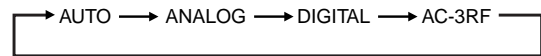

3 While SIGNAL SELECT is set to DIGITAL, AC-3 lights when a Dolby Digital signal is input, DTS lights when a DTS signal is input.

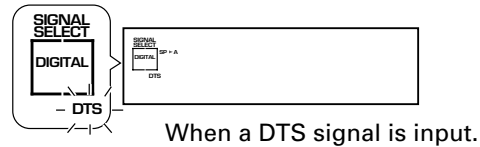
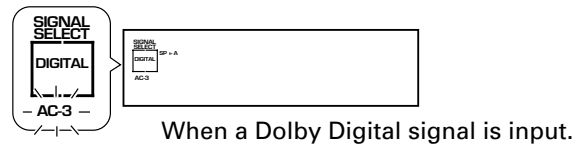

- In the AUTO setting, SIGNAL SELECT chooses the signal, based on availability, in the following order: AC-3 RF, DIGITAL, ANALOG.
- If all the DIGITAL INPUT SELECT (see p.33) choices are set to OFF, the SIGNAL SELECT will default to ANALOG.
- Because the audio from a karaoke microphone and LDs recorded with analog audio only is not output from the digital output, set SIGNAL SELECT to ANALOG to listen to these formats.
- This receiver can only play back Dolby Digital, PCM (32kHz, 44kHz, 48kHz, and 96kHz), and DTS digital signal formats. It cannot play back digital signals other than these so for those kinds of formats you'll have to play them back in an analog manner (making sure your equipment is hooked up with analog connections and setting the SIGNAL SELECT to ANALOG).
- When an LD or CD with DTS is played back with the SIGNAL SELECT set in ANALOG, digital noise caused by playing back the DTS directly (with no decoding) is output. To prevent noise, you need to make digital connections (See p.13) and set SIGNAL SELECT to AUTO.
- Some DVD players don't output DTS signals. For more details, refer to the instruction manual supplied with your DVD player.

Basic Playback

Reducing Noise During Playback (DIGITAL NR Function)

To reduce extraneous noise switch on DIGITAL NR. This noise reduction can be used with every mode except THX and MULTI CH IN.

1 Press the DIGITAL NR button on the remote control's Receiver MAIN screen or on the front panel.

Each press switches DIGITAL NR on or off.

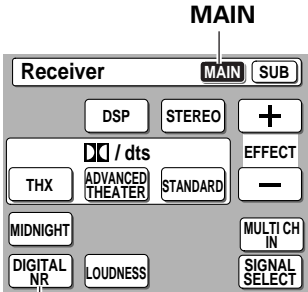

1

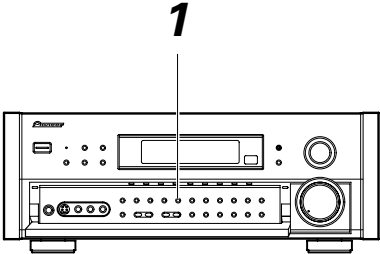

1



- In cases described below, noises may not be reduced even if DIGITAL NR is on.
 - Sudden noise
 - Extremely loud noise
 - Signals that do not contain many high frequencies
- DIGITAL NR is effective at and above levels shown below for each source.
 - STEREO (excluding 96 kHz)
 - analog input 10-18 dB
 - digital input 10-15 dB
 - AM/FM tuner 10-15 dB
 - DSP/ADVANCED/STANDARD/96 kHz stereo 6-10 dB
- Depending on the condition of the source, there may not be a noticeable improvement in the quality of the sound.
- You can't use the DIGITAL NR mode with the MULTI CH IN or THX modes.
- If you press DIGITAL NR in DIRECT mode the receiver will switch to STEREO mode.

Listening in MIDNIGHT Mode

This feature makes it possible to get excellent surround sound effects even when listening at low volumes. It can be used with a variety of surround sound sources and play soundtracks so that the quieter sounds are audible while the noisier sounds don't become overly loud or distorted. It does this by bringing all the sounds in a given soundtrack closer together in volume. Compare this feature with the DYNAMIC RANGE CONTROL (for Dolby Digital sources only) on p.41.



MAIN

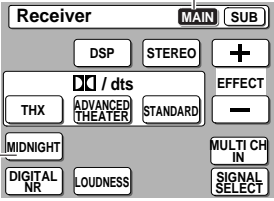

MIDNIGHT

Press the MIDNIGHT button on the remote control's Receiver MAIN screen.

Each press switches MIDNIGHT LISTENING mode on or off.



- The effect adjusts itself automatically in accordance with the volume level.
- You can't use the MIDNIGHT LISTENING mode with the THX or MULTI CH IN modes.
- If you press MIDNIGHT when in DIRECT mode the receiver switches to STEREO mode.

Listening in LOUDNESS Mode

The LOUDNESS mode allows you to boost the bass in a signal. It is useful for listening to music at low volumes.

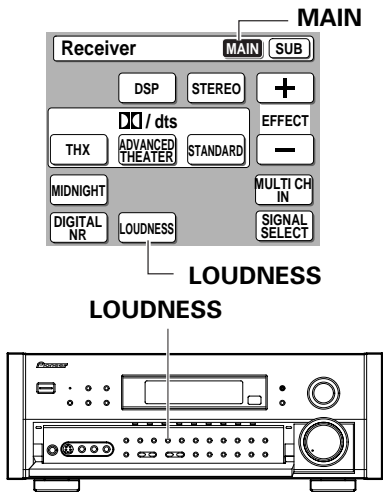

Press the LOUDNESS button on the remote control's Receiver MAIN screen or on the front panel.

Each press switches LOUDNESS mode on or off.



- You can't use the LOUDNESS mode with the MULTI CH IN or THX modes.
- If you press LOUDNESS in DIRECT mode the receiver will switch to STEREO mode.

Adjusting Bass and Treble (Tone Control)

You can use BASS +/- or TREBLE +/- buttons to adjust the low and high frequencies for each individual set of speakers. If the receiver is in STEREO mode you can only adjust the FRONT speakers. In a surround mode (STANDARD, ADVANCED THEATER, etc.) you can adjust the FRONT, CENTER, SURROUND and SURROUND BACK speakers. The TONE button can also be used to bypass the tone circuitry (See p.22).

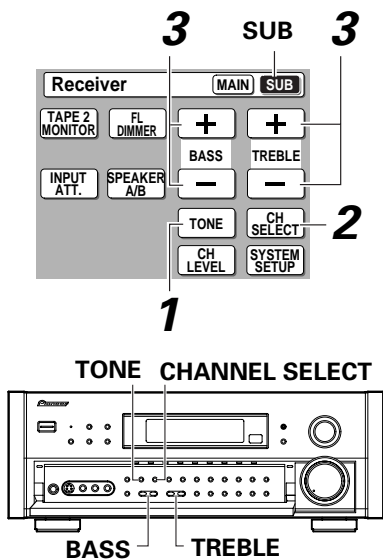

1 Press the TONE button on the remote control's Receiver SUB screen or front panel to put the receiver in tone adjust mode.

TONE: ON should appear in the display. If TONE: BYPASS appears, press the button again to get TONE: ON the tone adjust mode.

2 Press the CH SELECT button on the remote control or CHANNEL SELECT button on the front panel to cycle through the different tone adjust channels.

The button cycles through the possibilities in the following order:

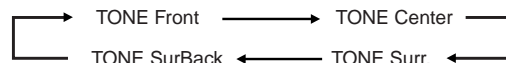

3 Use the BASS or TREBLE (+/-) buttons to adjust the low or high frequencies of each channel.

Display when using the TONE +/- buttons.

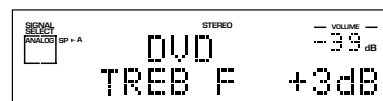

A few seconds after you finish adjusting the tone the receiver will revert to the sound mode it was in at the beginning of the process.



- The tone control can be adjusted in a range of ± 6 dB.
- The tone control cannot be adjusted in THX, MULTI CH IN.
- If the receiver is in DIRECT mode and you press the TONE button, TONE BYPASS will appear in the display, letting you know that you can't change the tone in DIRECT mode. Another press cancels DIRECT mode.

Basic Playback

MULTI CHANNEL IN Playback

MULTI CH IN allows you to connect an external decoder to enjoy certain types of specialized discs. To use MULTI CH playback follow the instructions below.

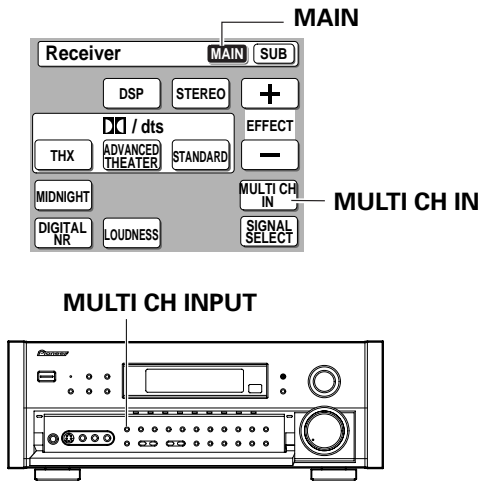

Press the MULTI CH IN button on the remote control's Receiver MAIN screen or the MULTI CH INPUT button on the front panel.

Each press switches the input between the previous mode and MULTI CH IN.



When MULTI CH IN is selected only the volume level can be set. All of this unit's other features (DIGITAL NR etc.) cannot be used. Also, In BYPASS mode all speaker settings and other setup settings have no effect.

MULTI CHANNEL IN Setting

There are two types of MULTI CH IN settings: ADJUST and BYPASS. In the former you can change the sound level and in the latter it's fixed. To move between the two settings follow the procedure below:

⏻ STANDBY/ON

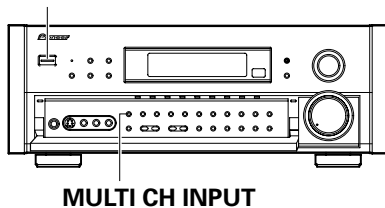

1 Put receiver in STANDBY.

2 While holding down the MULTI CH INPUT button press the ⏻ STANDBY/ON button.

The setting will change depending on what state the receiver was previously in. For a few seconds the display will show you which MULTI CH setting you are now in.

ADJUST: Use the ADJUST setting when you want to be able to control each channel level individually.

BYPASS: This setting is good for getting the cleanest possible signal. In this setting you won't be able to change each channel individually.

We recommend using BYPASS and the default setting is BYPASS.

96 kHz 24 bit Performance

This receiver is capable of playing back advanced DVD discs which are recorded in 96 kHz/24 bit format (these are all stereo discs) and any source recorded in 96 kHz and up to 24 bit. The receiver will automatically read the format of the disc and play accordingly (of course the SIGNAL SELECT will have to set to AUTO or DIGITAL to read the DVD soundtrack). When the receiver plays a 96 kHz/24 bit disc "96 kHz" and whatever mode you're using (for example "STEREO," "DIRECT" or "DNR") will appear in the display.

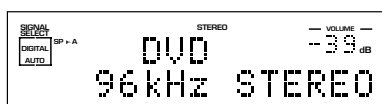

- When a 96 kHz/24 bit disc is played back the volume may be louder than that of a normal disc.
- Some DVD players cannot play 96 kHz/24 bit discs. Check the manual of your DVD player to make sure.
- During this playback the player enters the STEREO mode and you can use the controls available in STEREO mode (LOUDNESS, MIDNIGHT, TONE controls, etc., see p.50-51).
- With 96 kHz/24 bit discs you are able to use MULTI CH IN playback and the TAPE 2 MONITOR.
- In 96 kHz/24 mode you can't use the STANDARD, ADVANCED THEATER, THX, or DSP modes.

Direct Playback

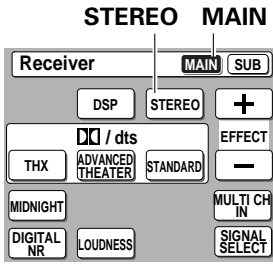

STEREO/DIRECT

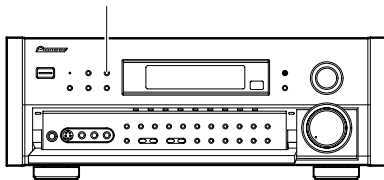

Use the **STEREO** button on the remote control or the **STEREO/DIRECT** button on the front panel to alternate between **STEREO** and **DIRECT** mode.

The DIRECT mode will give you the most accurate reproduction of two channel (stereo) sources but won't let you add any effects to the sound.



- None of the tone controls or other sound modes can be used with DIRECT playback.
- If the receiver is in a different mode than STEREO to start with the first push of the STEREO button will put it in STEREO mode. After that the button will toggle the receiver between STEREO and DIRECT mode.
- Relatedly, see the explanation of the TONE button on p.22 and the STEREO mode on p.45.

Adjusting the Brightness of the Display

Use the FL DIMMER button to adjust the brightness of the fluorescent display (FL=fluorescent display).

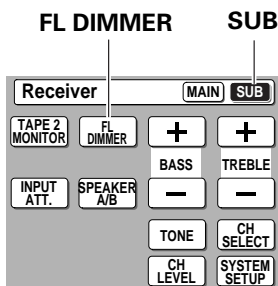

FL DIMMER

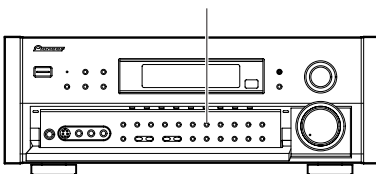

Use the **FL DIMMER** button on the remote control or the front panel to alternate between the different levels of brightness.

Four levels of brightness ranging from very dim to very bright can be selected. Each press changes the brightness of the display. When cycling through the options, the default brightness can also be selected.



Please note: It is a feature of this unit that the fluorescent display will be brighter for a few seconds after you choose a function (like DVD/LD, CD, etc.) and then get softer. This will still happen when you adjust the brightness but the new setting will be the one the display softens to.

Using the Tuner

Automatic and Manual Tuning

The following steps show you how to tune in FM and AM radio broadcasts using the automatic (search) and manual (step) tuning functions. If you already know the exact frequency of the station you want, see "Direct Access Tuning" on the following page.

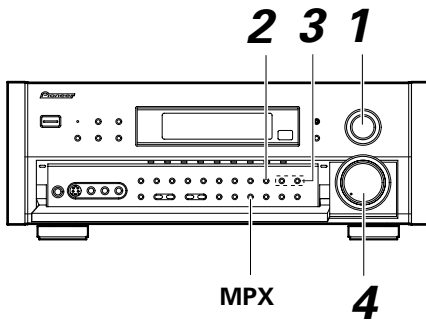
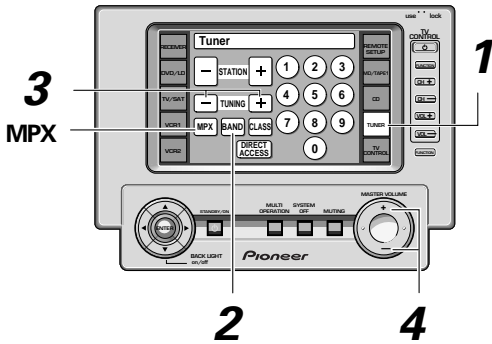

1 Press the TUNER.

On the remote, this selects the TUNER function on the receiver and sets the remote to the TUNER operation mode.



2 Press the BAND button to select the band (FM or AM).

Each press switches the band: FM ↔ AM

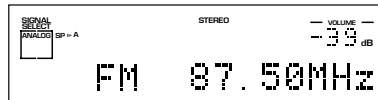

3 Tune in the station.

For Automatic Tuning

Press and hold TUNING $-/+$ for about one second, then release.

The tuner starts searching the selected band and stop automatically at the first station it locates. Repeat to locate other stations.

For Manual Tuning

- To change frequencies one step at a time, press TUNING $-/+$ repeatedly.
- To change frequencies quickly, hold down TUNING $-/+$ and release when you reach the frequency you desire.

4 Adjust the MASTER VOLUME buttons on the remote control or the MASTER VOLUME on the front panel.

MPX Mode

If the TUNED or STEREO indicators do not light when tuning an FM station, because the station is too far away or the broadcast signal is weak, press MPX on the remote control or front panel to switch to MONO reception. This should improve reception enough for you to enjoy the broadcast.

Direct Access Tuning

The following steps show you how to tune directly to a specific frequency using the remote control.

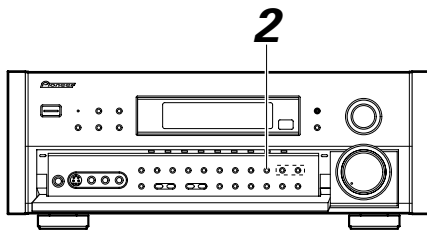
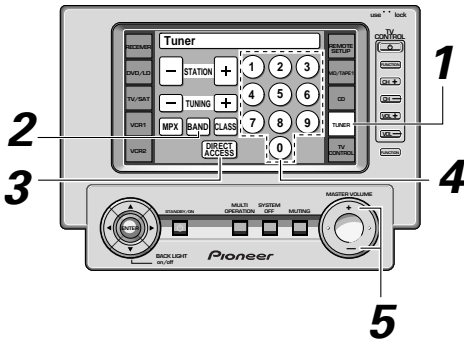

1 Press the TUNER.

This selects the TUNER function on the receiver and sets the remote to the TUNER operation mode.

2 Press the BAND button to select the band (FM or AM).

Each press switches the band : FM ↔ AM

3 Press the DIRECT ACCESS button to activate the direct access tuning mode.

The cursor blinks in the display on the front panel.

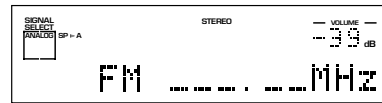

4 Use the number buttons to enter the frequency of the station you want.

Example:

To tune station 106.00 (FM), press: ① → ⑥ → ⑥ → ① → ①

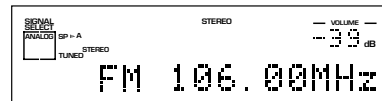

To cancel before inputting the frequency

Press DIRECT ACCESS, and enter the frequency again.

5 Adjust the MASTER VOLUME buttons on the remote control or the MASTER VOLUME on the front panel.

Memorizing Frequently Used Stations

The following steps show you how to memorize up to 30 radio stations in 3 classes (each holding 10 stations). When memorizing FM frequencies, the receiver also memorizes the MPX mode (STEREO or MONO).

Using the front panel

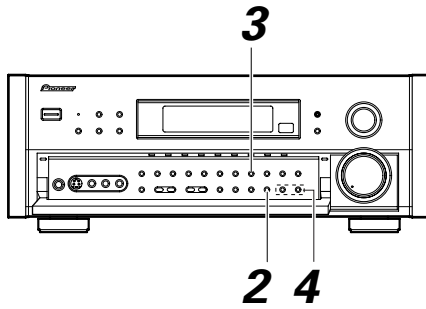

1 Tune in the station you want.

See "Automatic and Manual Tuning" or "Direct Access Tuning" on page 54 and 55.

2 Press the MEMORY button to activate the memory function.

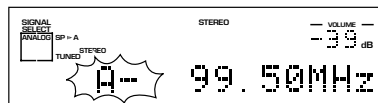

3 Press the CLASS button repeatedly to select a class number.

Each press switches the display:

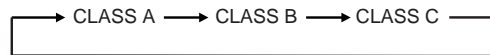

4 Press the STATION +/- buttons repeatedly to select a channel (0~9) within the respective class.



The station is memorized automatically after 5 seconds.

If you want to escape from the MEMORY mode press the MEMORY button again.

Repeat steps 1 through 4 to memorize up to 30 stations.

Recalling Memorized Stations

Using the remote control

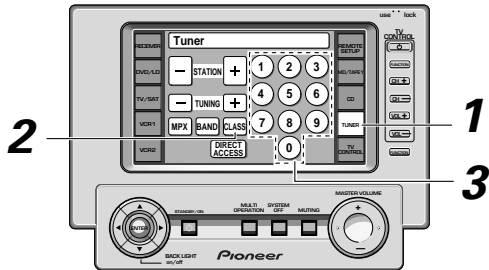

1 Press the TUNER.

This selects the TUNER function on the receiver and sets the remote to the TUNER operation mode.

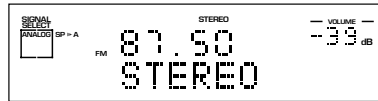

2 Press the CLASS button repeatedly to select a class number.

Each press switches the display:

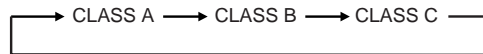

3 Use the NUMBER buttons to select the channel you desire.

To select channel 7, press ⑦.

To select channel 0, press ⑩.

For example : If 99.50 MHz (FM) was memorized in class A at channel 7.

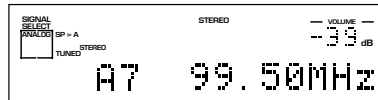

To step through each channel in order

Press the STATION -/+ buttons repeatedly.

Using the front panel

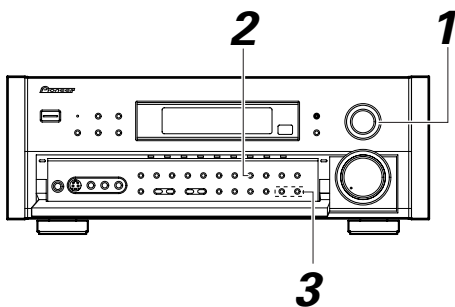

1 Select the TUNER function.

2 Press the CLASS button repeatedly to select a class number.

3 Press the STATION -/+ buttons repeatedly to select the channel you want.

Remote Control of Other Components

Setting Up the Remote Control to Control Other Components

In addition to controlling the receiver, the supplied remote control can operate your other components (VCR, TV, LD, CD, etc.) after you program it to do so. In this way, instead of fumbling with many different controls and buttons, you only need to use one remote control. If your component(s) are listed in the remote control's memory, simply follow the steps below. If your component(s) are not listed, or if you want the remote to learn additional operations, you can use the learning mode to input the information from the remote controls supplied with your other components.

Recalling Settings Stored in the Remote Control

The following steps show you how to recall the setting stored in the remote control. Once a setting is recalled and the component assigned, you can use this remote to easily operate the component.



- You can press the BACK button at any time to go back a screen.
- See "Using Remote Control with Other Components" on pages 64 through 71 to operate your other components.

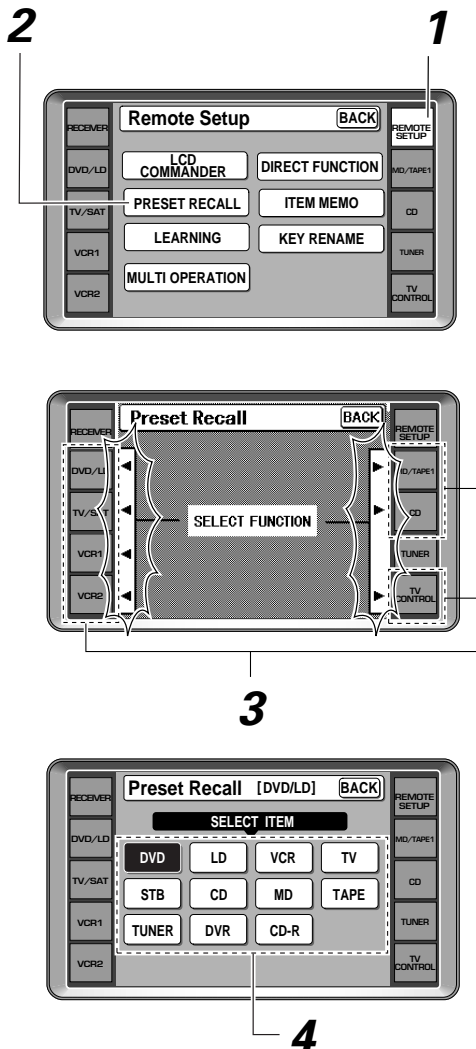

1 Press the REMOTE SETUP.

The REMOTE SETUP menu appears on the remote control's screen.

2 Press the PRESET RECALL button on the remote control.

The step by step process will appear on the remote control.

3 SELECT FUNCTION will appear on the remote control. Choose the button (for example, DVD/LD) you want to assign to control the component you want to operate (the TUNER button cannot be assigned).

Naturally it's easiest and most logical to assign the button that has the same name as the component you are setting up (for example, choose the CD button for your CD player).

In some cases, however, you may need to assign a button to a component with a different name. For example, one button is marked MD/TAPE 1. If you assign this button to your MD player you'll need to use a different button, like VCR 2, for your tape deck.

4 Choose the component you want to set up.

In the example in the diagram on the left, DVD was selected in step 3. Thus, [DVD/LD] appears in the top bar after Preset Recall.

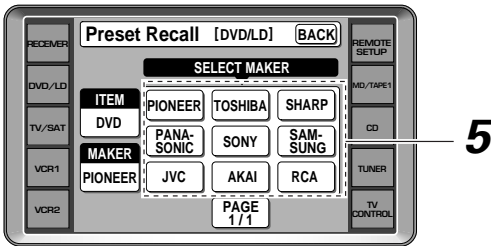

5 Select the name of the company that makes your component.

If there are two pages of company names, use the page +/- buttons to go back and forth between the two sets of makers' names. For explanation purposes, we'll use PIONEER as an example.

6 Press the NUMBER 1 button.

If the component you are trying to control turns on/off, the set up for this component is complete, but components that don't have a standby mode can't respond in this way. To test if you've set it up properly work through step 8. Then try using selecting the function you just set up (for example a CD player) and using the controls on this remote control. If the component does not respond, try working through the procedure again and pressing number 2 instead this time. Continue this procedure until one of the commands works.

If none of the commands seem to work, try the learning mode to program the component into the remote control. This is explained on the following page.

To go back a screen
press the BACK button.

To exit the process without inputting the commands
press the BACK button repeatedly.

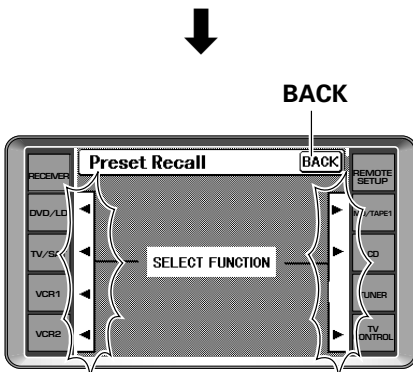
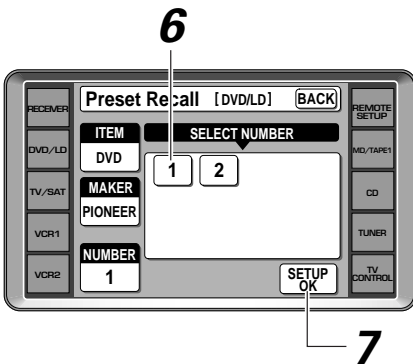

7 Press the SETUP OK button and the screen returns to SELECT FUNCTION so you can program another component into the remote control.

Repeat the process for all of your components. You may find you have components which do not correspond to the name on any function button (for example a cable TV tuner) or you have two components where only one button is provided (MD/TAPE 1). In this case, use step 3 to assign any available function button to the component you want to remote control.

For example, you may have a cable TV tuner and one video deck in your system. It would make sense to assign the VCR 2 function button to your cable TV tuner in step 3. The rest of the procedure is the same as before. Choose CATV in step 4. The only practical difference in this method is that you have to remember the VCR 2 function button is actually your cable TV tuner.

In this case, you would need to hook up your cable TV tuner to the input jacks marked VCR 2.

This method should help you customize the remote control for your system.

8 Press the BACK button repeatedly to leave the PRESET RECALL set up mode.

Remote Control of Other Components

Learning Mode: Programming Signals from Other Remote Controls

If preset codes are not available for your component(s), or the available preset codes do not operate correctly, you can use this procedure to program in signals from the remote control(s) of your other component(s). These steps can also be used to add further operations to the remote control screens that were successfully set with the stored settings (see p.58-59).

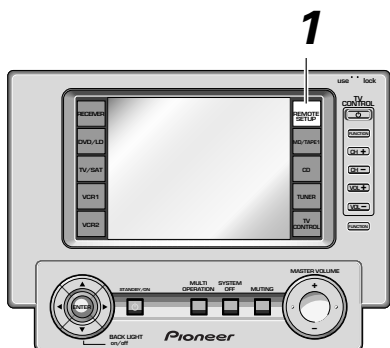

1 Press the REMOTE SETUP.

2 Press the LEARNING button.

If you want to cancel the REMOTE SETUP mode Press BACK. You will return to the receiver menu.

3 SELECT FUNCTION blinks on the remote control. Press the function button for the component you want to control (the TUNER button cannot be used).

For example purposes we will use the DVD/LD function.

4 Choose the command you want to teach the remote control and press the corresponding button on the LCD screen. The word "Learning" will blink in the top bar of the remote control screen.

For example, choose the ► (play) button to program this remote control to play your DVD player.

- The TV POWER, TV FUNC, TV CH +/- and VOL +/- buttons are only available for learning when programming TV CONTROL operations.
- Pressing BACK cancels the process.

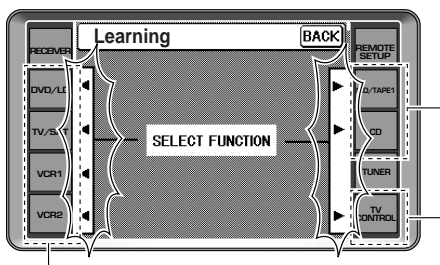
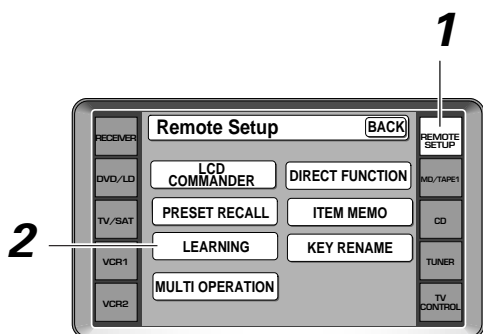

3

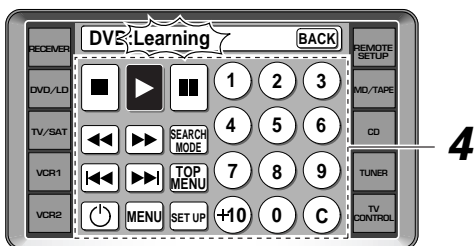

memo You can also program the ▲/▼/◀/▶ and ENTER cursor buttons with the LEARNING mode.

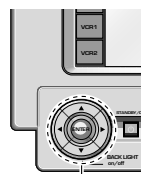

▲/▼/◀/▶ and ENTER cursor buttons

Remote Control of Other Components

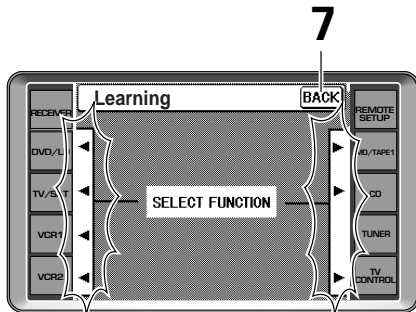
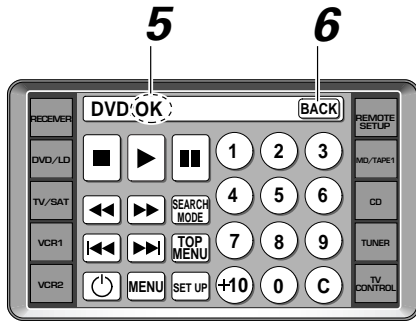

- 5 Point the two remote controls toward each other. Press the button on the other remote control corresponding to the operation you want to program.

LEARNING flashes in the display on the VSX-39TX remote control. After the process is complete and the command has been learned, OK will appear at the top of the remote control LCD display. If NG (no good) appears, it means that for some reason the command was not learned. Repeat steps 4 and 5 to teach the remote control of the VSX-39TX all the commands from the other remote control.

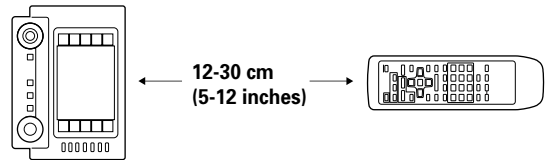

- 6 Press the BACK button to return to the LEARNING/SELECT FUNCTION screen.

Start again from step 3 to program all your components in this manner.

- 7 When you're done press the BACK button repeatedly to return to the REMOTE SETUP or RECEIVER menu.



Some commands from other remote controls cannot be learned, but in most cases the remotes just need to be moved closer together or farther apart.

Locking the Settings

This feature allows you to lock the SYSTEM SETUP and REMOTE SETUP settings so that they cannot be changed without unlocking them first. When they are locked you cannot enter the setting screen in these modes. The locking and unlocking procedures are done by the same process.

Unlocked symbol

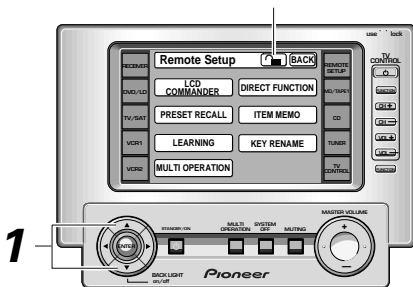

2 Locked symbol

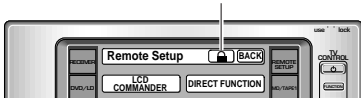

- 1 In the SYSTEM SETUP or REMOTE SETUP screens hold down the ▲/▼ buttons at the same time. While you're holding down the buttons a lock symbol will appear in the top bar of the remote control.

- 2 Press the lock symbol while holding down the above two keys. The setting will either lock or unlock depending on the state it was previously in.

From that time, if the screen is locked the lock symbol will appear when that screen is accessed.



The only exception to LOCKING THE SETTINGS is the LCD COMMANDER settings in the REMOTE SETUP screen. They can still be accessed even when the REMOTE SETUP screen is locked.

Item Memo

Use the ITEM MEMO capability to add more information to the remote control display screens for different functions, like your DVD or CD player. For example, you could add the name of the company that makes your component, then the top line of the screen for the respective component would read something like "DVD PIONEER".

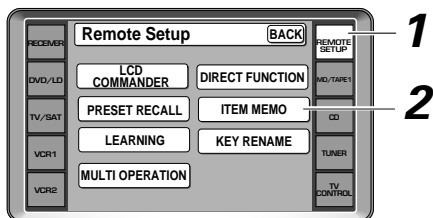

1 Press the REMOTE SETUP.

2 Press the ITEM MEMO button.

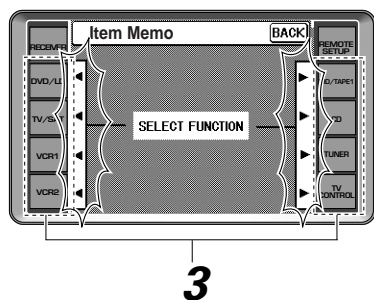

3 Press the FUNCTION button of the function/component you want to add additional information to, for example, DVD.

4 Use the LETTER and the NUMBER buttons to spell out the name you want to add.

The keyboard works the same as a conventional keyboard, if you press the SHIFT key the letters will be lower case. Another press returns them to capitals. You can include spaces and hyphens in the name.

You can input up to ten letter/numbers.

The DELETE key clears the letters/numbers from the right backwards.

The ALL CLEAR key erases everything that has been typed.

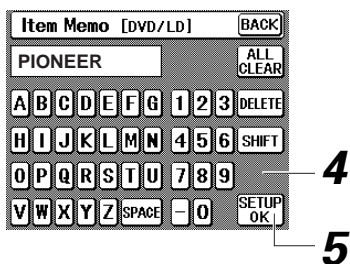

5 Press the SETUP OK button when the name appears in the bar as you want it on the function screen.

The COMPLETE screen will show for half a second to let you know the name was successfully input. The screen will then return to step two to allow you to input names for other functions/components.

6 Use the BACK button to return to the basic RECEIVER screen.

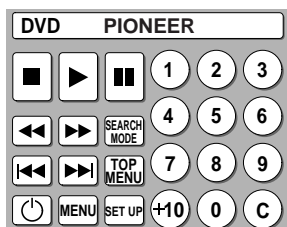

- You input up to ten letters or numbers. If you try to input more than ten the remote control will beep twice to let you know this can't be done.
- You can include spaces and hyphens if you want.
- You can input this kind of information for up to eight functions/components.
- If you start this process but want to stop it without inputting the information entered press the BACK key. This will return you to the previous screen without entering any of the information. You can use this button to return to screen where you started.

Key Rename

Use the KEY RENAME capability to rename the buttons (keys) on the remote control screens for different functions (DVD, etc.). You would want to do this if you taught a specific button a new operation on the previous two pages. For example, you could teach the SEARCH MODE button to be an audio key and the rename it "AUD".

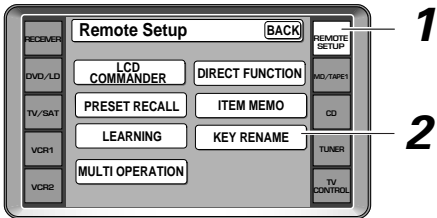

1 Press the REMOTE SETUP.

2 Press the KEY RENAME button.

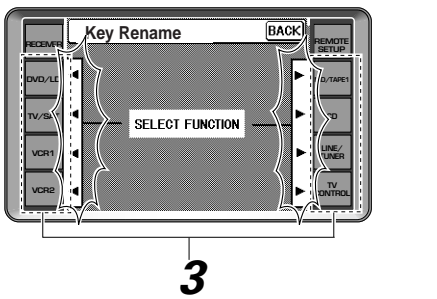

3 Press the FUNCTION button that has the button you want to rename, for example, "DVD".

4 Press the LCD button (▶, ■ etc.) that you want to rename.

5 Use the letter and number buttons to spell out the name you want to add.

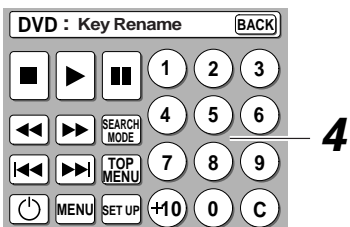

The screen will tell you the maximum number of letters/numbers you can input.

You can include spaces and hyphens in the name.

The DELETE key clears the letters/numbers from the right backwards.

The ALL CLEAR key erases everything that has been typed.

If you want to return to the previous name after you've input a new one press either the ALL CLEAR or DELETE buttons.

6 Press the SETUP OK button when the name appears in the bar as you want it on the function screen.

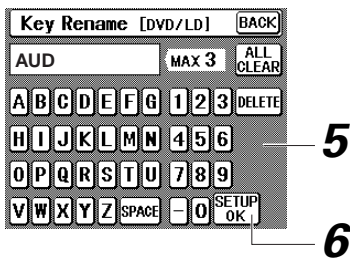

The COMPLETE screen will show for half a second to let you know the name was successfully input.

The screen will then return to step four to allow you to input names for other functions/components.

7 Use the BACK button to return to the basic RECEIVER screen.

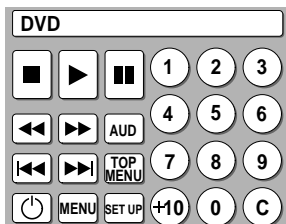

- If you try to input more letters/numbers than possible the remote control will beep twice to let you know this can't be done.
- You can include spaces and hyphens if you want.
- If you start this process but want to stop it without inputting the information entered use the BACK key.

Using Remote Control with Other Components

DVD or LD player operations



- The following operations are available from the receiver's remote control after you program your DVD or LD player into it, but some operations may need to be learned separately by the receiver (see "Setting Up the Remote Control to Control Other Components," p.58-61).
- To perform these operations, press the **DVD/LD** button to set the remote to the DVD or LD operation mode.
- For more information on individual commands consult the manual that came with the component.

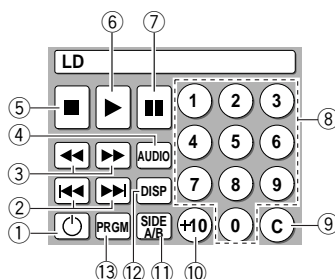
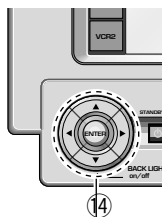
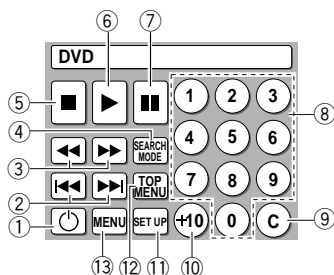

- ⏻**
Press to switch the DVD player on or off (not possible with all models, especially those without a standby mode).
- ⏮/⏭**
⏮ : Press to return to the beginning of the current chapter (track). Press repeatedly to return to the beginning of previous chapters (tracks).
⏭ : Press to advance to the beginning of the next chapter (track). Press repeatedly to advance to the beginning of following chapters (tracks).
- ⏪/⏩**
⏪ : Hold down for fast reverse playback.
⏩ : Hold down for fast forward playback.
- SEARCH MODE**
Press to perform a title, chapter/track or elapsed time search.
- Press to stop playback.
- ▶**
Press to start playback.
- ⏸**
Press to pause playback.
- Number buttons**
Use to select chapters (tracks).
- C**
Use to clear chapters (tracks) or programmed selections.
- +10**
Use when selecting chapter (track) numbers higher than 10.
- SET UP**
Use to set the DVD player mode available on some DVD players.
- TOP MENU**
Press to call up the menu programed on the DVD.
- MENU**
Use to display or close the title menu screen.
- ▲/▼/◀/▶/ENTER**
▲/▼/◀/▶ : Use to navigate through options on menu screens and to change settings.
ENTER : Use to implement settings selected with the cursor buttons or to set items highlighted in a menu.

- ⏻**
Press to switch the LD player on or off (not possible with all models, especially those without a standby mode).
- ⏮/⏭**
⏮ : Press to return to the beginning of the current chapter (track). Press repeatedly to return to the beginning of previous chapters (tracks).
⏭ : Press to advance to the beginning of the next chapter (track). Press repeatedly to advance to the beginning of following chapters (tracks).
- ⏪/⏩**
⏪ : Hold down for fast reverse playback.
⏩ : Hold down for fast forward playback.
- AUDIO**
The audio type can be changed between stereo and mono setting and between digital and analog setting.
- Press to stop playback.
- ▶**
Press to start playback.
- ⏸**
Press to pause playback.
- Number buttons**
Use to select chapters (tracks).
- C**
Use to clear chapters (tracks) or programmed selections.
- +10**
Use when selecting chapter (track) numbers higher than 10.
- SIDE A/B**
Use to change the LD between sides A and B.
- DISP**
Use to view disc time, elapsed time other information programmed into certain discs.
- PRGM**
Use to chapter (tracks) to program playback.

CD player operations



- The following operations are available from the receiver's remote control after you program your CD player into it, but some operations may need to be learned separately by the receiver (see "Setting Up the Remote Control to Control Other Components," p.58-61).
- To perform these operations, press the **CD** button to set the remote to the CD operation mode.
- For more information on individual commands consult the manual that came with the component.

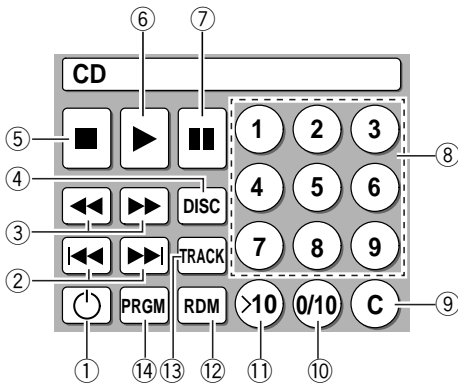

- ① **⏻**
Press to switch the CD player on or off (not possible with all models, especially those without a standby mode).
- ② **⏮/⏭**
⏮ : Press to return to the beginning of the current track. Press repeatedly to return to the beginning of previous tracks.
⏭ : Press to advance to the beginning of the next track. Press repeatedly to advance to the beginning of following tracks.
- ③ **⏮/⏭**
⏮ : Hold down for fast reverse playback.
⏭ : Hold down for fast forward playback.
- ④ **DISC**
Use to switch between discs with file type disc players.
- ⑤ **■**
Press to stop playback.
- ⑥ **▶**
Press to start playback.
- ⑦ **⏸**
Press to pause playback.
- ⑧ **Number buttons**
Use to select tracks.
- ⑨ **C**
Use to clear tracks or programmed selections.
- ⑩ **0/10**
Use to select tracks with high numbers. The button will increase the track number in increments of ten.
- ⑪ **>10**
You can also use this button when selecting track numbers higher than 10.
- ⑫ **RDM**
Use to select the random playback function. The CD player will play all the tracks on the disc in a random order.
- ⑬ **TRACK**
Use to select the track (not possible with all models).
- ⑭ **PRGM**
This button allows you to program a series of tracks into the tracks into the CD player (may not be possible with some CD players).

Remote Control of Other Components

MD operations



- The following operations are available from the receiver's remote control after you program your MD recorder into it, but some operations may need to be learned separately by the receiver (see "Setting Up the Remote Control to Control Other Components," p.58-61).
- To perform these operations, press the **MD/TAPE1** button to set the remote to the MD operation mode.
- For more information on individual commands consult the manual that came with the component.

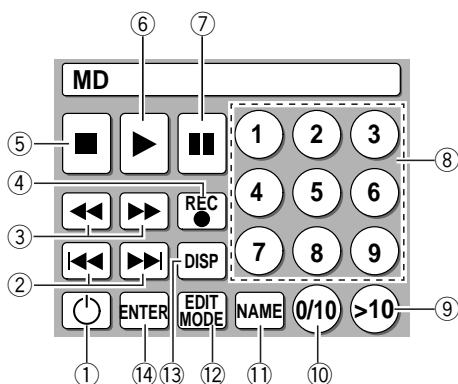

- ① Press to switch the MD recorder on or off (not possible with all models, especially those without a standby mode).
- ② **◀▶**: Press to return to the beginning of the current track. Press repeatedly to return to the beginning of previous tracks.
▶▶: Press to advance to the beginning of the next track. Press repeatedly to advance to the beginning of following tracks.
- ③ **◀◀▶▶**: Hold down for fast reverse playback.
▶▶◀◀: Hold down for fast forward playback.
- ④ **● REC**
Press to start recording (may put some decks in REC PAUSE mode).
- ⑤ Press to stop playback or recording.
- ⑥ Press to start playback.
- ⑦ **||**
Press to pause playback or recording.
- ⑧ **Number buttons**
Use to select tracks.
- ⑨ **>10**
You can also use this button when selecting track numbers higher than 10.
- ⑩ **0/10**
Use to select tracks with high numbers. The button will increase the track number in increments of ten.
- ⑪ **NAME**
Use to name tracks or programmed selections.
- ⑫ **EDIT MODE**
Allows you to edit names and numbers of tracks.
- ⑬ **DISP**
Allows you to change the display mode of the MD.
- ⑭ **ENTER**
Enters the changes you have made in the EDIT MODE.

TV operations



- The following operations are available from the receiver's remote control after you program your TV into it, but some operations may need to be learned separately by the receiver (see "Setting Up the Remote Control to Control Other Components," p.58-61).
- To perform these operations, press the **TV/SAT** or **TV CONTROL** button to set the remote to the TV operation mode.
- For more information on individual commands consult the manual that came with your TV.
- The "Standard" screen will appear when presetting the TV/SAT (or any other) function button. When presetting the TV CONTROL function button the "Digital" TV screen will appear.

Standard TV screen

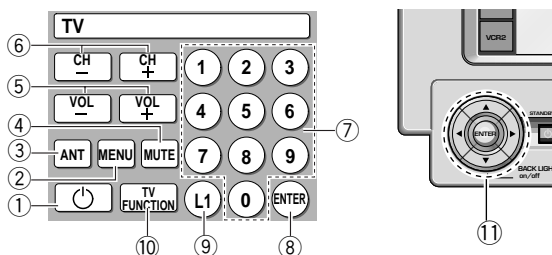

Digital TV screen

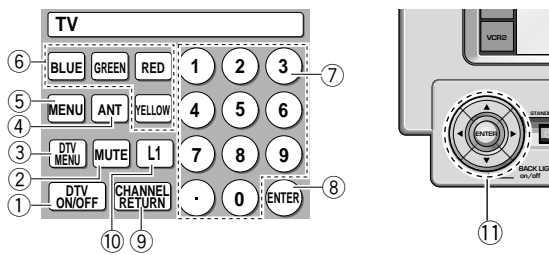

- ① **Power**
Press to switch the TV on or off (not possible with all models, especially those without a standby mode).
- ② **MENU**
Use to select different menus on a DTV screen.
- ③ **ANT**
Use to select the type of antenna you have hooked up to your TV.
- ④ **MUTE**
Press to mute or restore the volume.
- ⑤ **VOL (-/+)**
Press to control the volume of the TV.
- ⑥ **CH (-/+)**
Use these buttons to change the channel of the TV.
- ⑦ **Number buttons**
Use to select a specific TV channel.
- ⑧ **ENTER**
Use to select the channel specified with the number buttons (not all models require this step).
- ⑨ **L1**
A freely assignable key where you can enter any command you like—refer to p.60-61 This receiver is capable of playing back advanced DVD discs which are recorded in 96 kHz/24 bit format (these are all stereo discs) and any source recorded in 96 kHz and up to 24 bit-for more on this.
- ⑩ **TV FUNCTION**
Press TV FUNCTION to select the TV for remote control operation.

- ⑪ **▲/▼/◀/▶/ENTER**
▲/▼/◀/▶ : Use to select or adjust items on the menu screen.
ENTER : Use to activate the selected function.
- ① **DTV ON/OFF**
Press to switch the DTV mode on or off.
- ② **MUTE**
Press to mute or restore the volume.
- ③ **DTV MENU**
Press to select the DTV menu.
- ④ **ANT**
Use to select the type of antenna you have hooked up to your TV.
- ⑤ **MENU**
Use to select different menus on a DTV screen.
- ⑥ **BLUE/GREEN/RED/YELLOW**
Use to make selections from the DTV menu.
- ⑦ **Number buttons**
Use to select a specific TV channel.
- ⑧ **ENTER**
Use to select the channel specified with the number buttons (not all models require this step).
- ⑨ **CHANNEL RETURN**
Use to return to the previous channel.
- ⑩ **L1**
Freely assignable key where you can enter any command you like—refer to p.60-61 for more on this.
- ⑪ **▲/▼/◀/▶/ENTER**
▲/▼/◀/▶ : Use to select or adjust items on the menu screen.
ENTER : Use to activate the selected function.



You can operate your TV by using the TV control buttons as well.

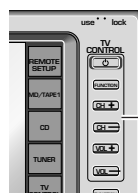

TV CONTROL buttons

Remote Control of Other Components

CATV operations



- The following operations are available from the receiver's remote control after you program your CATV into it, but some operations may need to be learned separately by the receiver (see "Setting Up the Remote Control to Control Other Components," p.58-61).
- To perform these operations, press the **TV CONTROL** button to set the remote to the CATV operation mode.
- For more information on individual commands consult the manual that came with the your CATV.

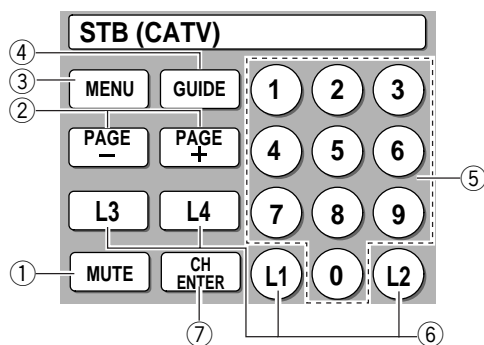

- ① **MUTE**
Press to mute or restore the volume.
- ② **PAGE (-/+)**
Use to displays other pages of on-screen information if there is too fit one screen.
- ③ **MENU**
Use to display the main menu.
- ④ **GUIDE**
Use to display the Program Guide screen.
- ⑤ **Number buttons**
Use to select a specific TV channel.
- ⑥ **L1-4**
Freely assignable keys where you can enter any command you like-refer to p.60-61 for more on this.
- ⑦ **CH ENTER**
Use to select the channel specified with the number buttons (not all models require this step).

STB (DTV) operations



- The following operations are available from the receiver's remote control after you program your digital tuner into it, but some operations may need to be learned separately by the receiver (see "Setting Up the Remote Control to Control Other Components," p.58-61).
- To perform these operations, press the **TV/SAT** button to set the remote to the DIGITAL TUNER operation mode.
- For more information on individual commands consult the manual that came with the component.
- When presetting a PIONEER digital tuner, this screen will appear.

Digital Tuner screen

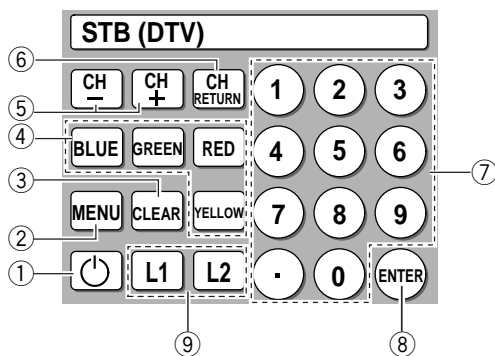

- ①
Press to switch the digital tuner on or off (not possible with all models, especially those without a standby mode).
- ② **MENU**
Use to turn the main menu on or off.
- ③ **CLEAR**
Use to clears on-screen display.
- ④ **BLUE/GREEN/RED/YELLOW**
Use to make selections from the DTV (Digital TV) menu.
- ⑤ **CH -/+**
Use to change channels on the satellite tuner.
- ⑥ **CH RETURN**
Use to return to the previous channel.
- ⑦ **Number buttons**
Use to select satellite channels.
- ⑧ **ENTER**
Use to select the channel specified with the number buttons (not all models require this step).
- ⑨ **L1-2**
Freely assignable keys where you can enter any command you like-refer to p.60-61 for more on this.

STB (satellite tuner) operations



- The following operations are available from the receiver's remote control after you program your satellite tuner into it, but some operations may need to be learned separately by the receiver (see "Setting Up the Remote Control to Control Other Components," p.58-61).
- To perform these operations, press the **TV/SAT** button to set the remote to the SAT operation mode.
- For more information on individual commands consult the manual that came with the component.
- When presetting a satellite tuner other than one made by PIONEER, screen1 will appear.
- When presetting a PIONEER satellite tuner, screen 2 will appear.

Satellite Tuner screen 1

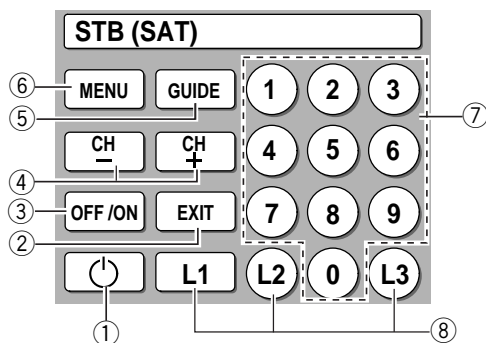

- ① Press to switch the satellite tuner on or off (not possible with all models, especially those without a standby mode).
- ② **EXIT**
Press to exit the current setting of the SAT.
- ③ **OFF/ON**
Press to switch the satellite tuner off.
- ④ **CH -/+**
Use to change channels on the satellite tuner.
- ⑤ **GUIDE**
Use to turn the program information screen on or off.
- ⑥ **MENU**
Use to turn the main menu on or off.
- ⑦ **Number buttons**
Use to select satellite channels.
- ⑧ **L1-3**
Freely assignable keys where you can enter any command you like-refer to p.60-61 for more on this.

Satellite Tuner screen 2

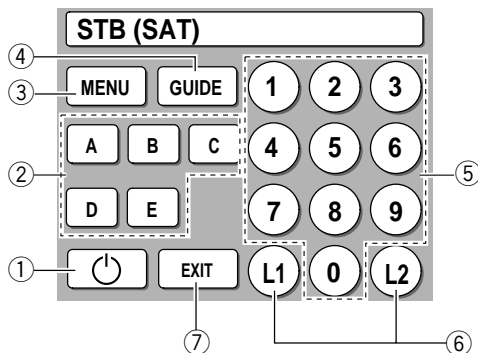

- ① Press to switch the satellite tuner on or off (not possible with all models, especially those without a standby mode).
- ② **A/B/C/D/E**
Use to make selections from the SAT menu.
- ③ **MENU**
Use to turn the main menu on or off.
- ④ **GUIDE**
Use to turn the program information screen on or off.
- ⑤ **Number buttons**
Use to select satellite channels.
- ⑥ **L1-2**
Freely assignable keys where you can enter any command you like-refer to p.60-61 for more on this.
- ⑦ **EXIT**
Press to exit the current setting of the SAT.

Remote Control of Other Components

Cassette deck operations

You can use this remote control to control a single or a double cassette deck after you program the deck player into it. If you have a regular cassette deck with only one set of tape heads use the buttons on the right marked "SINGLE/DECK II". If you have a double cassette deck with use the buttons on the left for deck I and the buttons on the right for deck II.



- **The following operations are available from the receiver's remote control after you program your Cassette deck into it, but some operations may need to be learned separately by the receiver (see "Setting Up the Remote Control to Control Other Components," p.58-61).**
- To perform these operations, press the **MD/TAPE1** button to set the remote to the TAPE operation mode.
- For more information on individual commands consult the manual that came with the component.

DECK I

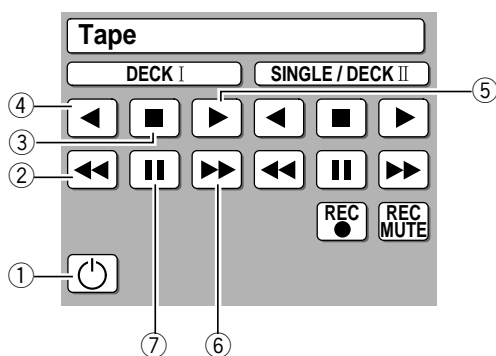

- ① Press to switch the cassette deck on or off (not possible with all models, especially those without a standby mode).
- ② Press to rewind the tape.
- ③ Press to stop playback or recording.
- ④ Press to start reverse playback (for auto reverse decks).
- ⑤ Press to start playback of the side of the cassette which has been loaded as the front.
- ⑥ Press to fast forward the tape.
- ⑦ Press to pause playback or recording.

SINGLE/DECK II

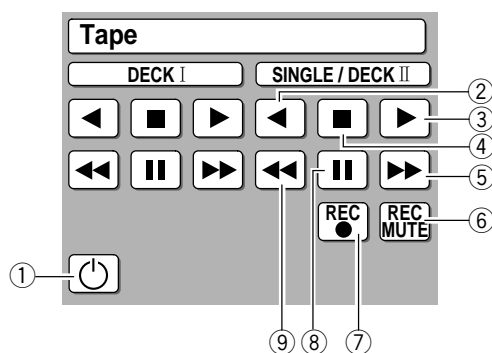

- ① Press to switch the cassette deck on or off (not possible with all models, especially those without a standby mode).
- ② Press to start reverse playback (for auto reverse decks).
- ③ Press to start playback of the side of the cassette which has been loaded as the front.
- ④ Press to stop playback or recording.
- ⑤ Press to fast forward the tape.
- ⑥ **REC MUTE**
Press and hold to make a blank space during recording. The recording will be muted for as long as the button is held down.
- ⑦ **REC ●**
Press to start recording (may put some decks in REC PAUSE mode).
- ⑧ Press to pause playback or recording.
- ⑨ Press to rewind the tape.

VCR operations



- The following operations are available from the receiver's remote control after you program your VCR deck into it, but some operations may need to be learned separately by the receiver (see "Setting Up the Remote Control to Control Other Components," p.58-61).
- To perform these operations, press the **VCR 1** or **VCR 2** button to set the remote to the VCR operation mode.
- For more information on individual commands consult the manual that came with the component.

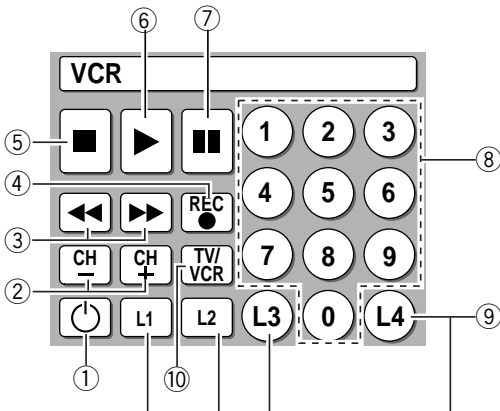

- ① **Power**
Press to switch the VCR on or off (not possible with all models, especially those without a standby mode).
- ② **CH -/+**
Use to change channels on the VCR's tuner.
- ③ **◀▶**
◀▶ : Press to rewind the tape.
▶▶ : Press to fast forward the tape.
- ④ **REC ●**
Press to start recording.
- ⑤ **■**
Press to stop playback.
- ⑥ **▶**
Press to start playback.
- ⑦ **||**
Press to pause playback.
- ⑧ **Number buttons**
Use to change channels on the VCR.
- ⑨ **L1-4**
Freely assignable keys where you can enter any commands you like-refer to p.60-61 for more on this.
- ⑩ **TV/VCR**
Use this button to switch the VCR between it's TV tuner and the video function.

Other screen for preset operations

In addition to the operations mentioned in this section up to this point, the VSX-39TX is equipped with remote control screens to deal with a variety of cutting edge technologies and components that may or may not have appeared on the market yet. These include: CD-R (CD write-once discs deck), CD-RW (CD rewritable discs deck), and the latest innovation, DVD video recorder.

If you have one of these components you can access the preset screen by going to the preset recall section of this manual (p. 58-61) and following the instructions therein. Select the appropriate screen from the list presented and assign it to a function button in the manner described. Then you can access the screen by simply pressing that function button.

Below are a list of the screens of cutting edge components you can access.

CD-R operations

Essentially all the controls are the same as those explaining the screen for a regular CD player with the added feature of being able to record. The (● REC) and the REC MUTE buttons are explained on p. 66 under the MD explanations.

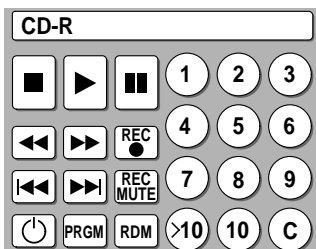

DVR (DVD Recorder) operations

Essentially all the controls are the same as those explaining the screen for a regular DVD player with the added feature of being able to record. The record button (● REC) is explained on p. 66 under the MD explanations. REC STOP is a special DVD video recorder control that stops the recording.

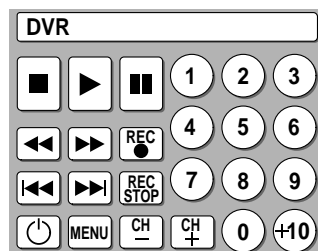

Using Other Functions

Recording from Audio Components

The following explanations show you how to record an analog or digital audio signal. Note that your analog components cannot record a player that is only connected digitally (and vice-versa). If you want to record from a digital component to an analog one (for example, a tape deck), or vice-versa, the digital component it must be connected via analog jacks and you need to set the SIGNAL SELECT switch to ANALOG. To make exact digital copies (of digital sources like CDs) both the source component and the recorder must be connected with digital connections. See p.12 for more on analog audio connections and p.13 for digital audio connections.



The receiver's volume, channel level, balance, TONE, DNR, MIDNIGHT, LOUDNESS and surround effects have no effect on the recorded signal and the MULTI CH IN cannot be recorded. In some cases, digital recordings have copy guard protections and making a digital copy is not possible. In this case you can only copy them in an analog manner.

Functions that can be recorded

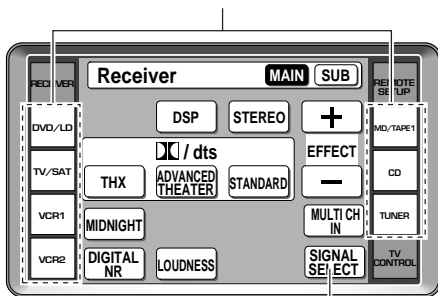

1 (if necessary)

1 Select the source component. Set SIGNAL SELECT according to the source component's signal (ANALOG or DIGITAL).

Press the SIGNAL SELECT button on the remote control (or use the button on the front panel) and choose ANALOG.

2 Start recording with a recorder.

3 Playback the source to be recorded.

Record monitor (TAPE 2 MONITOR)

If you connect a cassette deck with a record monitor function to the TAPE 2 MONITOR jacks, you can listen to the sound of an analog recording as it is being recorded.

Press TAPE 2 MONITOR to switch between the sound of the recording (TAPE 2 indicator on) and the sound of the source component (TAPE 2 indicator off).

Recording from Video Components

The following operations show you how to record audio and video to the video tape recorder connected to the VCR 1 / DVR or VCR 2 jacks. Note that all signals coming out of these jacks will be analog and it is not possible to record Dolby Digital/DTS soundtracks.



The receiver's volume, channel level, balance, TONE, DIGITAL NR, MIDNIGHT, LOUDNESS and surround effects have no effect on the recorded signal.

Functions that can be recorded

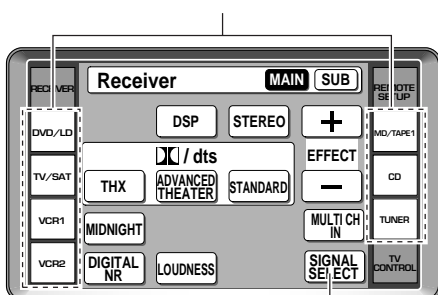

1 (if necessary)

1 First, decide the component you'd like to record and put the receiver in that function. Set the SIGNAL SELECT to analog.

Press the SIGNAL SELECT button on the remote control (or use the button on the front panel) and choose analog. Recording DIGITAL or RF signals is not possible.

2 Start recording with VCR 1 or VCR 2 (etc.).

3 Playback the source to be recorded.

Video Select

This function allows you to listen to one sound source while you watch a different video source on your TV. The sound source is set in the normal fashion as is explained on p.47. You then alter the video input with the VIDEO SELECT button.

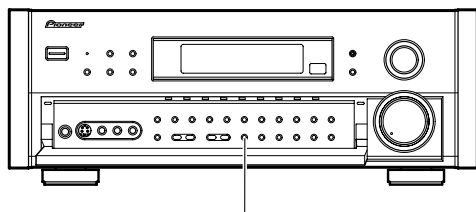

VIDEO SELECT button

Press the VIDEO SELECT button on the front panel to cycle through the different possible video inputs.

The first press shows the video input you are currently using. After that pressing VIDEO SELECT cycles through the possibilities in the following order:

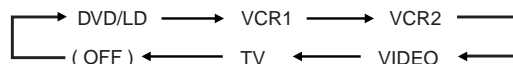

The OFF setting means the AUDIO and VIDEO source are the same. (Also, if one of the MD/TAPE 1, CD, TUNER, or PHONO functions are selected the VIDEO SELECT will be set to OFF.)

After choosing a video input the display on the receiver will show that input for about 5 seconds and then revert to showing the sound mode the receiver is in.

The VIDEO SELECT remains set to the input you chose until you change the audio input.

If you change audio functions the receiver will reset itself to make the video and audio inputs correspond. Also, if you switch the power of the receiver OFF when you turn it back on the video and audio inputs will reset so that they correspond.

Multi Operations

Multi operations allow you to tell the receiver and your other components to do a number of things with the push of only two buttons on the LCD commander. For example, you can program the unit to turn on your TV, turn on your DVD player and start playing the loaded DVD. This allows you to freely decide which operations you want performed as well as the order in which you want them performed. The steps below show you how to program a string of up to 5 different operations based on eight possible components. You don't need to program the power of this unit to go on, it will do so automatically when multi operations are recalled.



Be sure to recall or learn the remote commands for each component before attempting multi operations (see "Setting Up the Remote Control to Control Other Components", p.58-61).

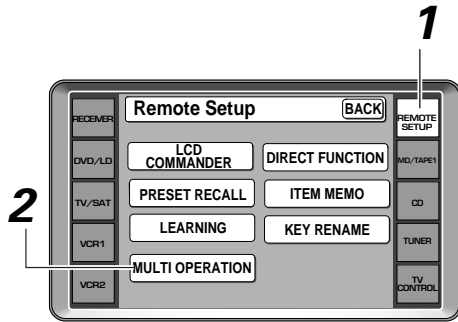

1 Press the REMOTE SETUP button.

2 Press the MULTI OPERATION button.

To cancel MULTI OPERATION
Press REMOTE SETUP button again

3 The next screen will instruct you to SELECT FUNCTION. Choose the component you want to start the MULTI OPERATION with and press its FUNCTION button.

For example purposes we'll use a DVD player as the first component to be set in this multi operation process.

To go back to the REMOTE SETUP screen
Press the BACK button.

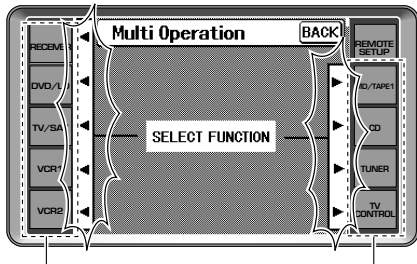

3

4 Next you should select the command number you want the process to start with. Of course it's logical to start with 1 so press command 1 (the box the 1 with inside it).

This tells the receiver this will be the first command.

To erase a command

Press the command button you want to erase and press the CLEAR button.

To go back one step

Press the BACK button.

To go back to the REMOTE SETUP screen

Press the BACK button repeatedly.

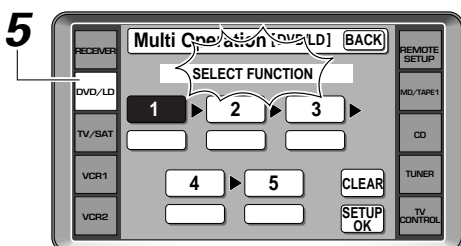
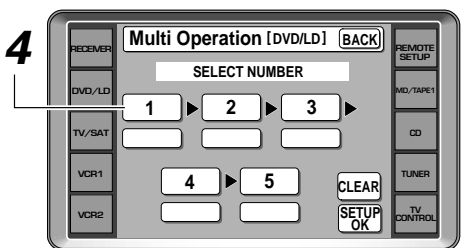

5 Select the component whose command you want to input (for example, a DVD player), and press that button on the remote control. The LCD screen for that component will appear on the remote control.

The screen for that component will appear in the LCD display.

To go back one step

Press the BACK button.

To go back to the REMOTE SETUP screen

Press the BACK button repeatedly.

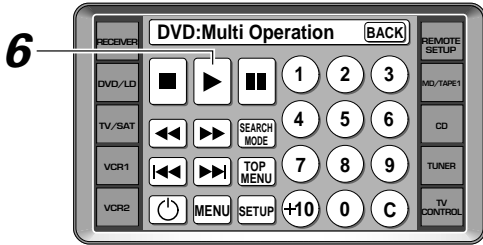

6 Select a command from the screen of the component (for example ► [play]).

The command and component chosen will appear in the window of command 1.

To erase a command

Press the command button you want to erase and press the CLEAR button.

To go back one step

Press the BACK button.

To go back to the REMOTE SETUP screen

Press the BACK button repeatedly.

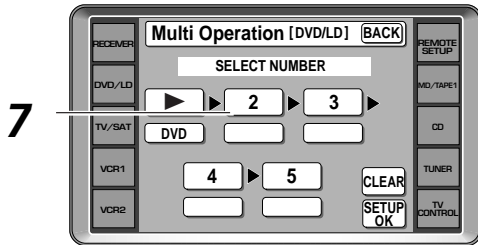

7 Repeat steps 4-6 to program a sequence of up to five commands.

You can assign MULTI OPERATIONS for up to 5 function buttons.

To erase a command

Press the command button you want to erase and press the CLEAR button.

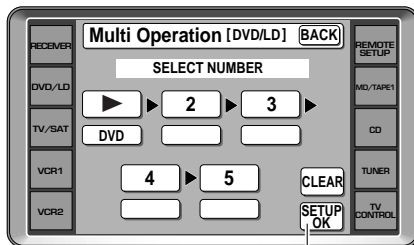

8 When done press SETUP OK to input the information.

After you press SETUP OK the LCD screen on the remote will flash COMPLETE to let you know the process has been stored.

The remote then returns to the mode allowing you to input more multi operations.

8

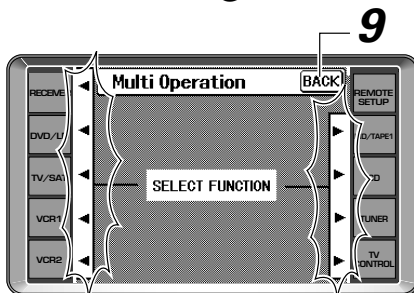

9 Press the BACK button repeatedly to leave the multi operation set up mode.



You don't need to program power on for PIONEER components (except for the first generation of Pioneer DVRs), they will go on automatically if a command for that unit is entered in the MULTI OPERATIONS settings. Also, your TV will go on automatically if a TV related command is entered in the MULTI OPERATIONS.

Performing multi operations

Do the following to use the MULTI OPERATIONS.

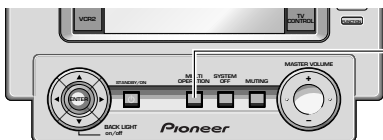

1 Press the MULTI OPERATION button.

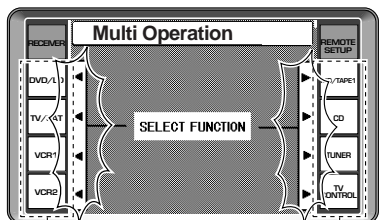

2 Press the function button that has been set up with multi operations.

The power of the main unit goes on and the programmed multi operations are performed automatically.

2

System OFF

The SYSTEM OFF feature allows you to tell the receiver and your other components to stop and turn off with the push of only one button on the LCD commander (**this feature will only work with components that have a standby mode**). For example, you can program the unit to stop your DVD, turn off your TV, turn off your DVD player and turn off the receiver itself. You don't need to program in other the power for PIONEER components, they will go off automatically in this mode. The receiver itself will go off automatically as well. The steps below show you how to program a string of up to 5 different SYSTEM OFF operations based on eight possible components.



Be sure to recall or learn the remote commands for each component before programming the SYSTEM OFF function (see "Setting Up the Remote Control to Control Other Components", p.58-61).

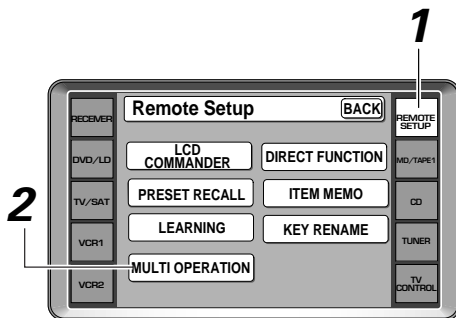

1 Press the REMOTE SETUP button.

2 Press the MULTI OPERATION button.

To cancel MULTI OPERATION
Press REMOTE SETUP button again.

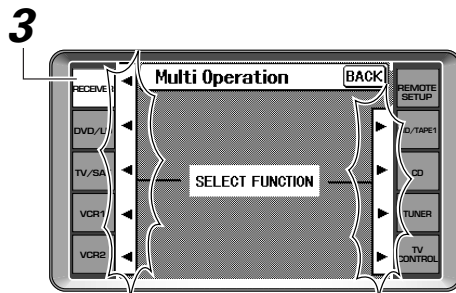

3 The next screen will instruct you to SELECT FUNCTION. Press the RECEIVER button.

To go back to the REMOTE SETUP screen
Press the BACK button.

4 Next you should select the command number you want the process to start with. Of course it's logical to start with 1 so press command 1 button (the box the 1 with inside it).

This tells the receiver this will be the first command. The number will become shaded.

To go back one step
Press the BACK button.

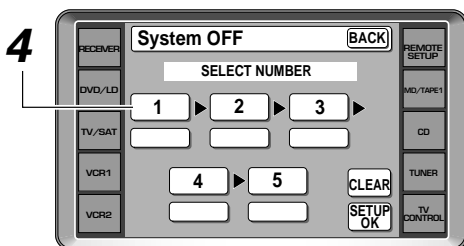

To go back to the REMOTE SETUP screen
Press the BACK button repeatedly.

5 Select the FUNCTION button of the component which you want to stop or turn off (for example, stop your DVD player) and press that FUNCTION button on the remote control.

The screen for that component will appear in the LCD display.

To go back one step
Press the BACK button.

To go back to the REMOTE SETUP screen
Press the BACK button repeatedly.

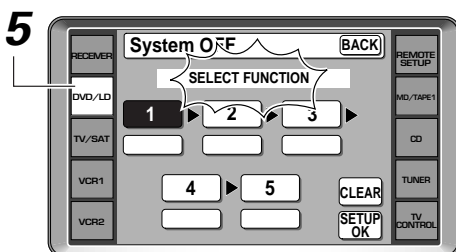

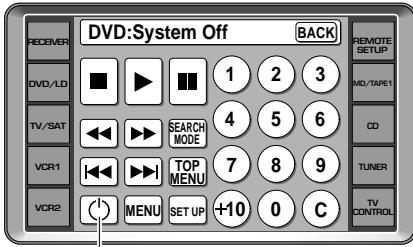

6

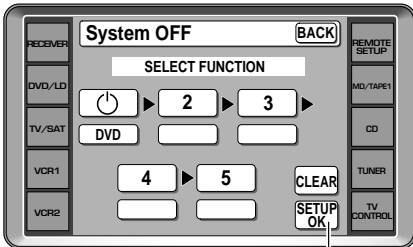

8

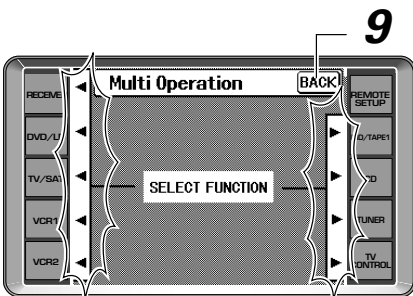

9

6 Select a stop or a power (⏻) command.

The command and component chosen will appear in the window of command 1.

To erase a command

Press the command button you want to erase and press the CLEAR button.

To go back one step

Press the BACK button.

To go back to the REMOTE SETUP screen

Press the BACK button repeatedly.

7 Repeat steps 4-6 to program a sequence of up to five stop or power off commands you want to input.

To erase a command

Press the command button you want to erase and press the CLEAR button.

To go back one step

Press the BACK button.

To go back to the REMOTE SETUP screen

Press the BACK button repeatedly.

8 When done press SETUP OK to input the information.

9 Press the BACK button repeatedly to leave the multi operation set up mode.

Using SYSTEM OFF

Do the following to use the SYSTEM OFF function.

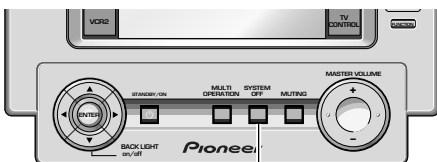

1

1 Press the SYSTEM OFF button.

The remote control must be on to be able to use this command but it can be in any mode.

All the components programmed into the SYSTEM OFF mode will stop and/or go off. The receiver will go off as well.

Setting up the DIRECT FUNCTION

The direct function will not be necessary for most users. It is designed in case you have an external video source connected to your TV (a video source that is not going through the VSX-39TX). For this explanation we'll call this the "external video deck." You'd like to control external video deck with this unit's remote control so you've assigned it a function button (for example purposes, the VCR 2 button). Yet, if you put the receiver in VCR 2 mode you'll get no picture on your TV because the external video deck signal is not going through the VSX-39TX. To get around this problem you set the DIRECT FUNCTION for VCR 2 to OFF. Now when you press VCR 2 function button you can control the external video deck with the remote but the receiver does not go into VCR 2 mode.

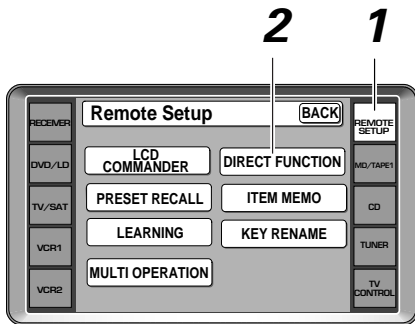

1 Press the REMOTE SETUP.

2 Press the DIRECT FUNCTION button.

3 Choose to set the DIRECT FUNCTION of each source to ON or OFF by pressing on the ON/OFF button.

A triangular arrow points from the ON/OFF button towards a small nub next to the function names (DVD/LD, CD, etc.) that can be turned ON/OFF. This nub will disappear if that DIRECT FUNCTION is turned OFF.

Subsequently the nub will not appear on any remote control screen if the DIRECT FUNCTION is OFF.

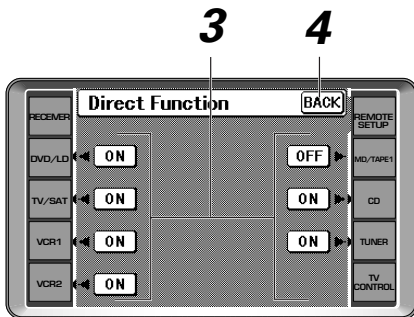

4 To leave the Direct Function mode press the BACK button.



The default setting for all DIRECT FUNCTIONS is ON.

Resetting the Remote Control

The following operations allow you to erase the settings stored in the remote control.

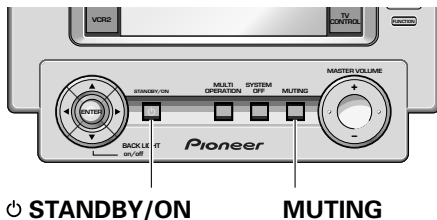

Hold down both the  STANDBY/ON button and MUTE button and then push the RESET tab under the battery cover on the back of the remote control.

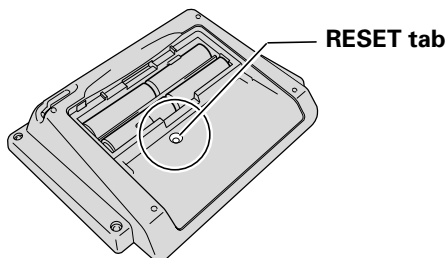

Multi-Room

When used together with an optional IR receiver, this receiver is capable of outputting two different sources at the same time. One to the (main) MONITOR OUT jack and SPEAKERS terminals and another to the MULTI ROOM & SOURCE AUDIO and MONITOR OUT jacks. Thus the VSX-39TX can power two independent systems, in separate rooms, listening to or watching different sources. With this system the two rooms can have completely independent power (the main room power can be off while the sub room is on) and the sub room can be controlled by this unit's remote control. If you go into the main room to change the source but forget the remote control it's not a problem. While in MULTI ROOM mode the input selector on the front panel of the VSX-39TX is able to change the input even though the receiver is off.

MULTI-ROOM connections

On the VSX-39TX, connect the IR receiver sensor to the MULTI-ROOM & SOURCE REMOTE IN jack, then connect a separate amplifier (and speakers) and TV monitor to the MULTI-ROOM & SOURCE AUDIO and MONITOR OUT jacks. All of this equipment should be placed in your sub-room as shown below.



- When connecting the IR receiver, be sure to connect it to the green MULTI-ROOM & SOURCE REMOTE IN jack, not the black CONTROL IN or OUT jacks.
- It is not possible to input digital signals into the SUB room, you must use analog signals.
- You can't use tone controls (etc.) and any surround modes in the SUB room.

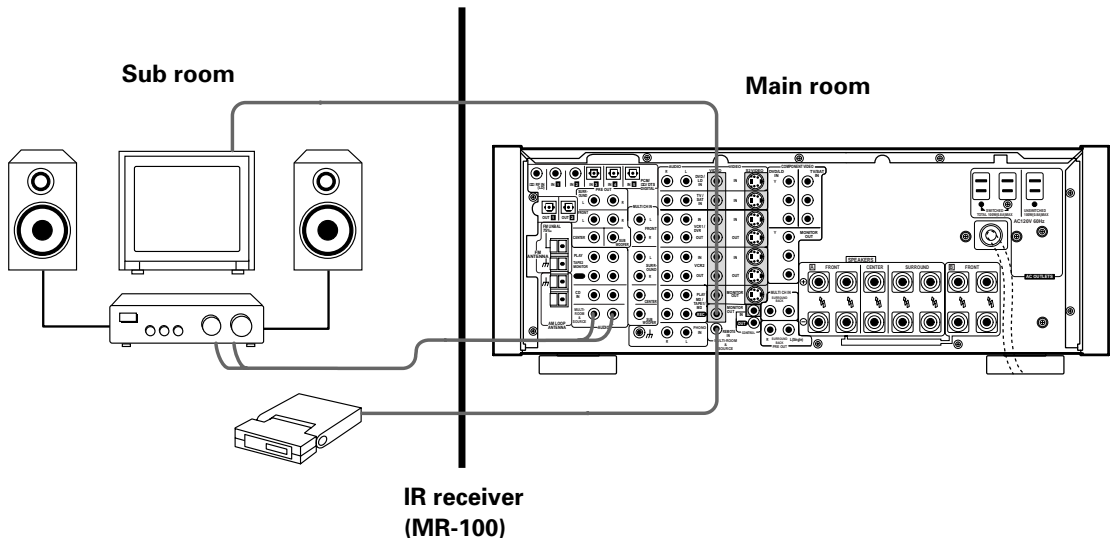

Set up example

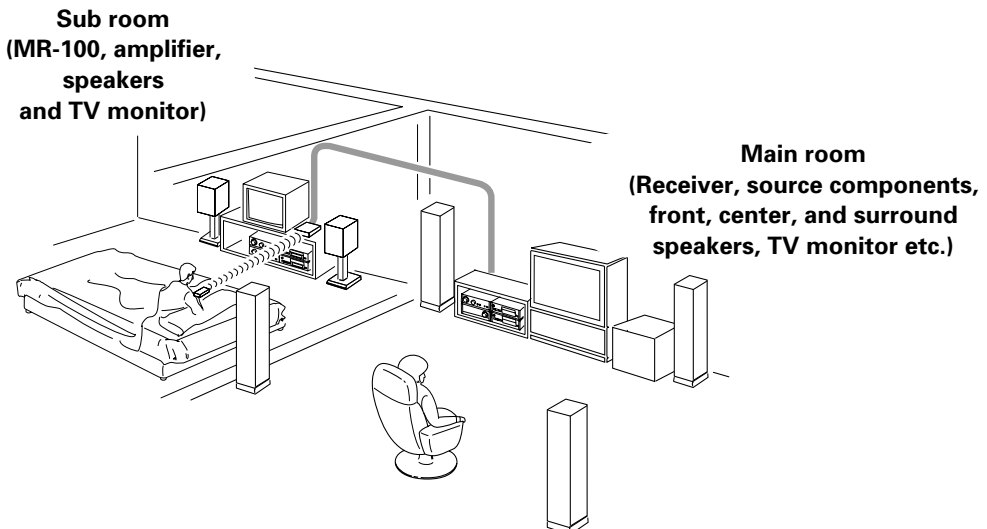

Using Other Functions

MULTI-ROOM set up

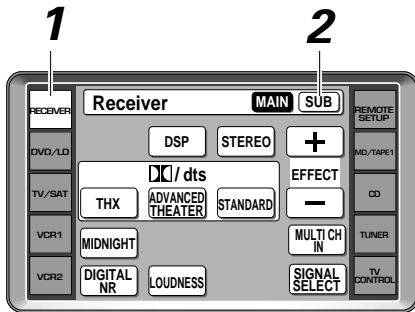

- 1 Turn on the receiver, your TV and press RECEIVER on the remote control.

Make sure your TV is set to the receiver.

- 2 Press the SUB button on the remote control.

- 3 Press the SYSTEM SETUP button.

The SYSTEM SETUP MENU appears on your remote control screen.

You can escape from this screen at any time by pressing BACK.

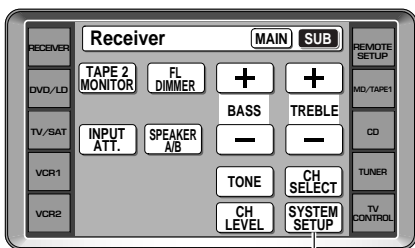

- 4 Press the MULTI ROOM button.

The MULTI ROOM menu appears on the remote control screen.

- 5 Select the VOLUME LEVEL by pressing VARIABLE or FIXED.

If you hook up a just a power amplifier in the sub room the VSX-39TX will act as a pre-amp. In this case choose VARIABLE for the VOLUME LEVEL setting. If you hook up a full integrated amplifier in the sub room (such as another Pioneer VSX receiver) choose FIXED for the VOLUME LEVEL setting.

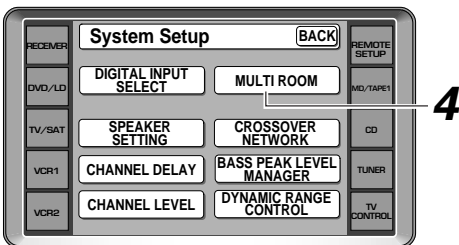

- 6 Select the IR RECEIVER type.

If you have the Pioneer-made MR-100 select PIONEER. If you have an IR RECEIVER from a different company, select OTHERS.

- 7 Press the SETUP OK button.

This message will appear in the receiver's display. If "ERROR" flashes in the display, perform the setup operations from the first step again.



These settings will be displayed on your TV screen.

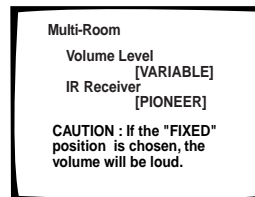
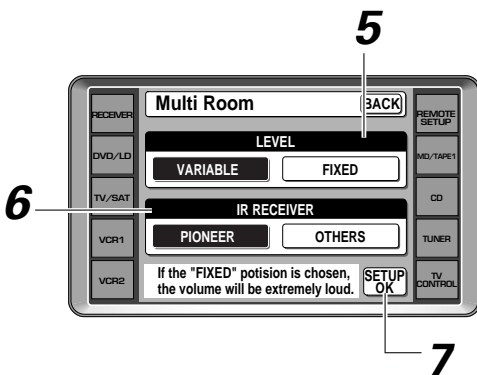

There may be some IR RECEIVERS that can't be used with this receiver. Check with a PIONEER representative to be sure.

CAUTION!

If the MULTI ROOM is set to FIXED the volume on the main unit will be set to maximum. Thus, when output, it will be extremely loud. Please set the master volume controls of the integrated amplifier in the sub room very low at first and experiment to find the correct volume.

Using the front panel with the MULTI-ROOM system

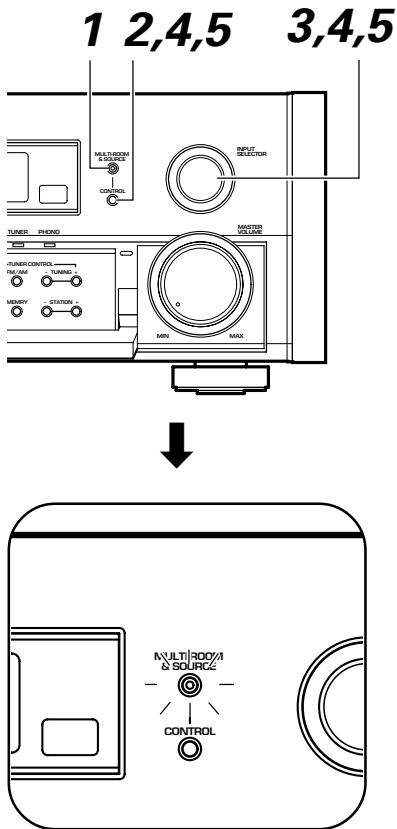

memo If you don't turn the multi room function off you won't be able to turn the entire main room system off.

1 Press the MULTI ROOM & SOURCE button.

The display shown below will illuminate when the receiver is in STANDBY mode. Also, the MR&S button will light.

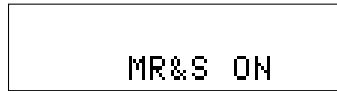

2 Press the CONTROL button.

The light on the button will start to blink.

3 Within ten seconds of step 2, select the FUNCTION with the INPUT SELECTOR.

For this example we'll use the TUNER function. The display shown below will illuminate.

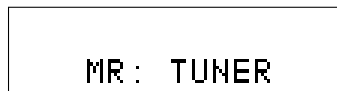

The INPUT SELECTOR steps through the functions in the following order:

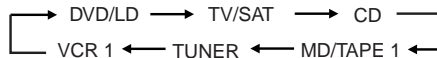

4 Press the CONTROL button again and use the INPUT SELECTOR to adjust the VOLUME. The volume can be adjusted in a range of -82dB to 0dB.

The display will appear as shown below.

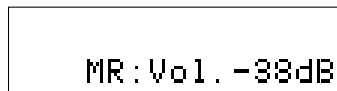

5 When in TUNER function, press the CONTROL button and use the INPUT SELECTOR to tune in the station.

The display will appear as shown below.

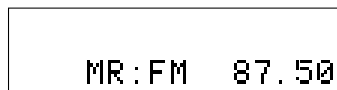

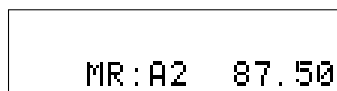

Turn the input selector until you get:

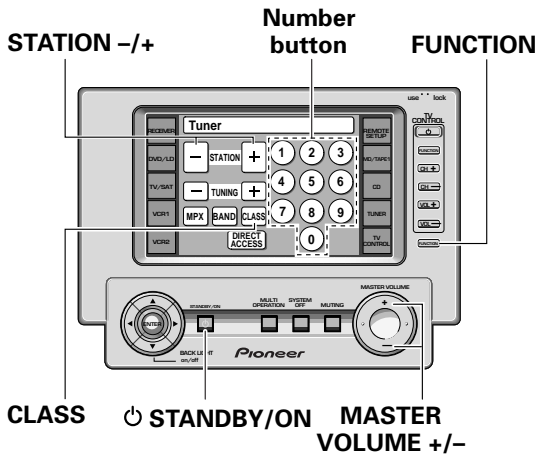

Using Other Functions

Using the remote control with the MULTI-ROOM system



1 From the sub room, point the remote control at the MULTI ROOM sensor and press a  STANDBY/ON button to turn the power on.

The MULTI ROOM & SOURCE button will light on the front panel in the main room.

2 Next press the FUNCTION button to select the sub room function.

You can also use a specific FUNCTION button (i.e the DVD/LD button) for this purpose.

3 Press MASTER VOLUME +/- to adjust the volume.

The following remote control buttons can be used to operate the receiver from the sub room.

-  **STANDBY /ON** button
- **FUNCTION** button (will not select PHONO, VCR 2 or VIDEO)
- **MASTER VOLUME +/-** buttons (for adjusting the sub-room's volume level, but can't be used when set to FIXED)
- **CLASS** button (for selecting the desired class)
- **STATION -/+** button (for recalling memorized radio stations (the tuner is selected automatically))
- **Number** button (0~9)

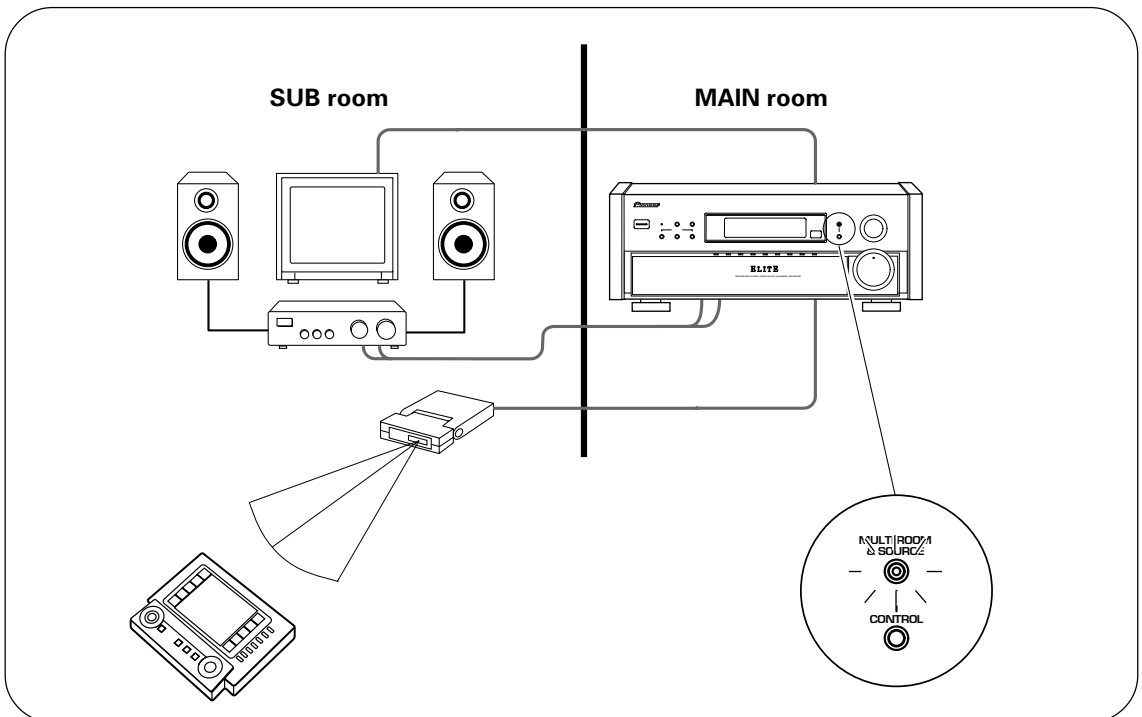



- Remote operation may not be possible if direct light from a strong fluorescent lamp is shining on the IR receiver remote sensor window.
- The tuner cannot be tuned to more than one station at a time. Therefore, changing the station in one room also changes the station in the other room. Please be careful not to change stations when recording a radio broadcast.
- The volume levels of the main and sub rooms are independent.
- When more than one remote control signal is transmitted at the same time, the receiver does not operate.
- When operating MULTI-ROOM & SOURCE with the MULTI-ROOM PRE OUT jacks connected to a SUB room amplifier which bears the PIONEER SR mark and has a remote sensor, both the IR receiver and the amplifier may receive remote control commands (making correct operation impossible). In this case, place the IR receiver and amplifier apart from each other, and point the remote control directly at the IR receiver during operation.
- If you plan to leave the MULTI ROOM feature off for a lengthy period please turn off the power in both the SUB and MAIN rooms. Make sure the STANDBY indicator turns red and the MR&S indicator goes off.
- If you send the SYSTEM OFF command from the SUB room by remote control, the power of both rooms will go off. Please be careful when making a recording in the MAIN room.

The PIONEER SR System: Operating other PIONEER components

Connecting an optional control cord allows you to operate other PIONEER components simply by pointing the receiver's remote control at the remote sensor on the front panel of the receiver. The receiver then sends the remote control signals to the other devices via the CONTROL OUT terminal.

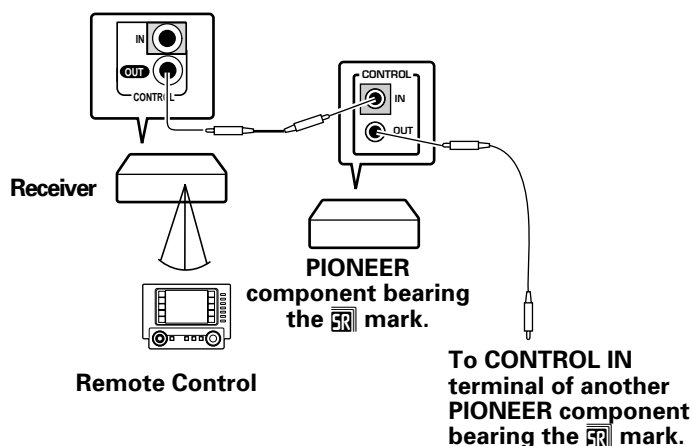

- You can also control PIONEER components (and those made by other manufacturers) by pointing the receiver's remote control directly at the respective component. This type of operation does not require control cords. All you have to do is recall the appropriate the stored settings (see p.47).
- If you use a remote control hooked up via the CONTROL IN jack with a control cord, you won't be able to use this unit's remote control.

Techno Tidbits & Problem-solving

Dolby Digital



Dolby Digital is a compression format which records the sound of 6 or 8 channels of the theater surround system (Dolby Digital) on the movie film digital track. Of the 6-8 channels, the sub woofer channel is intended for bass only, and because the frequency range is smaller than a main channel, the overall soundtrack is expressed as 5.1 or 7.1 channels. Dolby Digital is the name of the Dolby surround multi-channel digital system that was developed after the Dolby Surround System and Dolby Pro Logic Surround System.

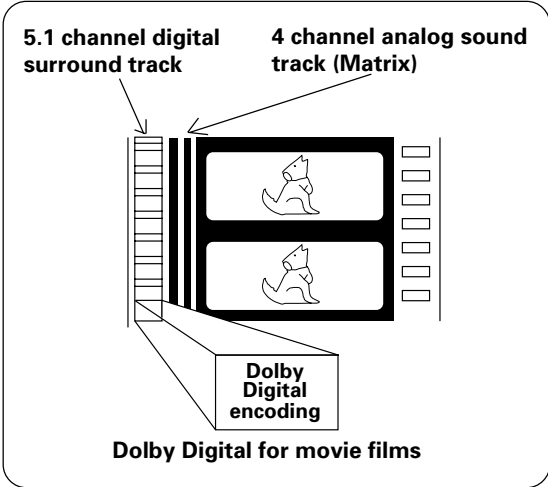

The number of movies made using Dolby Digital since 1992 has exceeded 300 and continues to increase. For compact disc players and laser disc digital sounds, 16 bits are used to sample the original analog audio waveform and sampling is carried out 44,100 times every second. However because an enormous amount of recording signal data is required for the multi channel system with this method, Dolby Digital is used to compress the data. In reproducing audio signals, the smaller the bit number used, the lower the sound quality. With Dolby Digital, drop in auditory sound quality is prevented by using masking technology and digital filtering technology based on the human auditory characteristics.

Laser disc format

Laser discs are now available on the market in large numbers. This means that the recording of different format audio signals on the laser disc raises the important question of compatibility with existing laser discs. Dolby Digital tracks on laser discs record signals using the space of one analog audio channel so it will maintain compatibility with existing discs and players. As shown in the following figure, the digital audio sounds of Dolby Digital discs can be played back as currently done. Analog sounds are played back by using the other channel without the Dolby Digital signals for monaural audio signals.

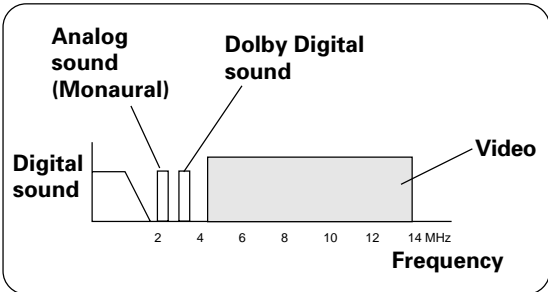

Comparison with Dolby Pro Logic Surround

Dolby Digital is also known as the 5.1 channel system. It is equipped with 5 channels (front left, front right, center, surround left, surround right) in the frequency range from 20 Hz to 20 kHz and an independent Low Frequency Effect (LFE) channel. The subwoofer channel is also called Low Frequency Effect (LFE). The subwoofer channel can be used as desired to enjoy strong bass sounds.

DTS



DTS has been adopted as a sound recording format in the latest movie theaters since the release of "JURASSIC PARK" in 1993, and has a good reputation for high quality sound and dynamic surround effects.

In this system, 6 channels of digital sound are recorded on CD-ROM, rather than on the film. DTS adopts a simultaneous playback format. With a low rate of compression of sound signals and a high rate of transmittance, a higher sound quality format is produced. Also, unlike the process of recording digital sounds on film directly, the only components required are a CD-ROM player as might be used with a personal computer and a DTS processor, and therefore less investment is required than with other formats. For this reason, the format is being introduced in more and more movie theaters, and is being adopted in home movie software (DVD, LD) and music software (5.1 channel CD). DTS has recently added a third surround channel to its system. This has come to be known as DTS Extended Surround or simply DTS-ES.

THX



THX is a Lucasfilm, Ltd. program dedicated to maximum accuracy in movie presentation. Movie sound tracks are recorded in large movie dubbing stages using movie theater equipment. For a sound track to be presented accurately in your home, special technologies are required. In your home the room is much smaller and has a bright sound, the speakers are very different and there are only six-eighths of them, plus, you sit much closer to each one of those speakers. Because of these differences we often miss the power and emotion that thrills us in a good movie. Now Pioneer and THX have teamed up to bring the full glory of accurate cinema sound to the comfort and convenience of your home.

Re-Equalization™ : In a theater the room is very large and dead sounding, you sit a long way back from the speakers and the speakers themselves are very specialized. Because a sound track recorded in this dead sounding space when it is played at home it sounds overbright. THX Re-Equalization adjusts for this difference in a very precise way.

Adaptive Decorrelation™ : When a sound track sends mono sound to the surround speakers it often seems to be coming from one side instead of from all around you as it would in a theater. Adaptive Decorrelation helps to correct this inaccuracy.

Timbre Matching™ : When recording a sound track it is very important that the surround sounds move smoothly and seamlessly around the theater. It is very distracting when sounds seem to jump from speaker to speaker. Timbre Matching helps to smooth the movement of the surround sounds even though you are using only two speakers.

Bass Peak Level Manager™ : Some Dolby Digital sound tracks can produce bass peaks that are undesirable in a home theater environment. The Bass Peak Level Manager allows you to set the maximum peak levels appropriate to your system. (Set this function according to the **BASS PEAK LEVEL MANAGER** instructions on page 40.)

Loudspeaker Position Time Synchronization™ : This feature allows you to adjust for the difference in the distance from each individual loudspeaker to the listening position. Doing this ensures that all the speakers operate in precise synchronization improving the seamless nature of the soundfield. (Set this function according to the **CHANNEL DELAY** instructions on p.36.)

THX Surround EX™ : THX Surround EX–Dolby Digital Surround EX is a joint development of Dolby Laboratories and the THX division of Lucasfilm Ltd.

In a movie theater, film soundtracks that have been encoded with Dolby Digital Surround EX technology are able to reproduce an extra channel which has been added during the mixing of the program. This channel, called Surround Back, places sounds behind the listener in addition to the currently available front left, front center, front right, surround right, surround left and subwoofer channels. This additional channel provides the opportunity for more detailed imaging behind the listener and brings more depth, spacious ambience and sound localization than ever before.

Movies that were created using the Dolby Digital Surround EX technology, when released into the home consumer market may exhibit a Dolby Digital Surround EX logo on the packaging. A list of movies created using this technology can be found on the Dolby web site at <http://www.dolby.com>.

Only receiver and controller products bearing the THX Surround EX logo, when in the THX Surround EX mode, faithfully reproduce this new technology in the home.

This product may also engage the "THX Surround EX" mode during the playback of 5.1 channel material that is *not* Dolby Digital Surround EX encoded. In such case the information delivered to the Surround Back channel will be program dependent and may or may not be very pleasing depending on the particular soundtrack and the tastes of the individual listener.

Troubleshooting

Incorrect operations are often mistaken for trouble and malfunctions. If you think that there is something wrong with this component, check the points below. Sometimes the trouble may lie in another component. Investigate the other components and electrical appliances being used. If the trouble cannot be rectified even after exercising the checks listed below, ask your nearest PIONEER authorized service center or your dealer to carry out repair work.

Symptom	Cause	Remedy
The power does not turn ON.	<ul style="list-style-type: none"> The power plug is disconnected. The protection circuit may have been activated. 	<ul style="list-style-type: none"> Connect the power plug to the wall outlet. Disconnect the power plug from the outlet, and insert again.
The unit does not respond when the buttons are pressed.	<ul style="list-style-type: none"> Static electricity caused by dry air. 	<ul style="list-style-type: none"> Disconnect the power plug from the outlet, and insert again.
No sound is output when a function is selected.	<ul style="list-style-type: none"> Improper connections. Sound is muted. The volume is turned down. The TAPE 2 MONITOR is ON. Speakers are turned OFF. DIGITAL/ANALOG switch is set incorrectly. 	<ul style="list-style-type: none"> Make sure the component is connected correctly (see p.12-21). Press MUTE on the remote control. Adjust MASTER VOLUME. Press the TAPE 2 MONITOR button. Press SPEAKERS (A/B) to select the speakers you connected. Set SIGNAL SELECT (see p.49).
No image is output when a function is selected.	<ul style="list-style-type: none"> Improper connections. The input source is not properly selected. 	<ul style="list-style-type: none"> Make sure the component is connected correctly (see p.12-21). Press the correct function button.
Considerable noise in radio broadcasts.	<ul style="list-style-type: none"> Incorrect frequency. The antenna is not connected. RF and/or digital cables are near the antenna terminals and wires. 	<ul style="list-style-type: none"> Tune in the correct frequency. Connect the antenna (see p.18). Route RF and digital cables away from the antenna terminals and wires.
	<p>FM broadcasts</p> <ul style="list-style-type: none"> The FM antenna is not fully extended or is poorly positioned. Weak radio signals. 	<ul style="list-style-type: none"> Fully extend the FM wire antenna, position for best reception, and secure to a wall. Connect an outdoor FM antenna (see p.18).
	<p>AM broadcasts</p> <ul style="list-style-type: none"> The AM antenna is poorly positioned. Weak radio signals. Interference caused by other equipment (fluorescent lamp, motor, etc.). 	<ul style="list-style-type: none"> Adjust the direction and position for best reception. Connect an additional internal or external AM antenna (see p.18). Turn off the equipment causing the noise or move it away from the receiver. Place the antenna farther away from the equipment causing the noise.
Broadcast stations cannot be selected automatically.	<ul style="list-style-type: none"> Weak radio signals. 	<ul style="list-style-type: none"> Connect an outdoor antenna (see p.18).
Subwoofer output is very low.	<ul style="list-style-type: none"> Settings route signal away from subwoofer. 	<ul style="list-style-type: none"> To get more signal to the subwoofer set it to PLUS or choose SMALL for the FRONT speakers (see p.34-35).
When playing an LD the SIGNAL SELECT is on RF but there is still no sound.	<ul style="list-style-type: none"> The LD is not a Dolby Digital compatible disc. 	<ul style="list-style-type: none"> Set the SIGNAL SELECT to analog (make sure your LD player is hooked up with analog connections in addition to digital and RF connections, see p.14).
When playing a Dolby Digital / DTS source the 5.1 Channel indicator doesn't light.	<ul style="list-style-type: none"> The Dolby Digital / DTS source is not 5 channels. 	<ul style="list-style-type: none"> There is no problem with the receiver but if you want 5 channel sound you must play a 5 channel source.

Techno Tidbits & Problem-solving

Symptom	Cause	Remedy
No sound from surround or center speakers.	<ul style="list-style-type: none"> • Speaker settings are incorrect. • The rear and/or center levels are turned down. • The surround and/or center speakers are disconnected. 	<ul style="list-style-type: none"> • See "SPEAKER SETTING" on p.34-35 to check the speaker settings. • See "CHANNEL LEVEL" p.37 to check the speaker levels. • Connect the speakers (see p.19).
Sound is produced from some components, but not from digital components.	<ul style="list-style-type: none"> • SIGNAL SELECT is set incorrectly. • The digital inputs are assigned incorrectly, or not at all. 	<ul style="list-style-type: none"> • Set SIGNAL SELECT to "AUTO" or according to the type of connections made (see p.49). • Set the digital input settings correctly (see p.33).
No sound is output or a noise is output when software with DTS is played back.	<ul style="list-style-type: none"> • SIGNAL SELECT is set to "ANALOG". • A DVD player not compatible with DTS is used, or the setting of the DVD player is incorrect. • The digital output level has been turned down on a CD player or other component equipped with digital output level adjustment capability. (The DTS signal has been altered by the player, and cannot be read.) • The speakers are turned OFF. 	<ul style="list-style-type: none"> • Make digital connections (see p.13-14) and set SIGNAL SELECT to "AUTO" (see p.49). • Refer to the instruction manual supplied with the DVD player. • Set the digital volume level of the player to full, or to the neutral position. • Turn the speakers ON.
The sound is output intermittently when software with DTS is played back.	<ul style="list-style-type: none"> • Disc being played back has a huge amount of information on it. 	<ul style="list-style-type: none"> • Use the STANDARD mode to get the best results (see memo, p.43,47).
When a search is performed by a Dolby Digital / DTS compatible CD player during playback, noise is output.	<ul style="list-style-type: none"> • The search function performed by the player interferes with the reading of digital information. 	<ul style="list-style-type: none"> • This is not a malfunction, but be sure to turn the volume down to prevent the output of loud noise from your speakers.
Cannot be remote controlled.	<ul style="list-style-type: none"> • The remote control batteries have worn out. • Too far away or bad angle of operation. • There is an obstacle between the receiver and the remote control. • Strong light such as fluorescent light is shining onto the unit's remote control signal light-receiving window. • A cord is connected to the CONTROL IN terminal on this unit. • The IR -Receiver type is mismatched with the setting. • The SETTING LOCK on the remote control is turned ON. • The lock switch on the remote control is set to LOCK. 	<ul style="list-style-type: none"> • Replace the batteries (see p.10). • Operate within 7 m, 30° of the remote sensor on the front panel (see p.11). • Remove the obstacle or operate from another position. • Avoid exposing the remote sensor on the front panel to direct light. • Connect cord to the correct jack. • Disconnect the IR Receiver from the rear panel, and set to the other IR Receiver type using the remote control. • Turn the SETTING LOCK to OFF (see p.61). • Set the lock switch to USE (see p.11).
The display is dark.	<ul style="list-style-type: none"> • The FL DIMMER button is pushed. 	<ul style="list-style-type: none"> • Press FL DIMMER on the front panel repeatedly to return to the default setting (see p.53).
The OVER indicator is constantly lit.	<ul style="list-style-type: none"> • If you are using an analog source, the signal is too strong. 	<ul style="list-style-type: none"> • Press the INPUT ATT button (see p.28).
When playing a Dolby Digital / DTS format LD there is noise audible on the soundtrack.	<ul style="list-style-type: none"> • If you are using a digital source, there is too much information for the receiver to handle. • The SIGNAL SELECT is on ANALOG. 	<ul style="list-style-type: none"> • For  / DTS sources put the receiver in STANDARD mode (see p.43,47). • Set the SIGNAL SELECT to DIGITAL.

Techno Tidbits & Problem-solving

Symptom	Cause	Remedy
You can't get DIGITAL to come up when using the SIGNAL SELECT button.	<ul style="list-style-type: none"> • Either the digital connections or the DIGITAL INPUT SELECT is incorrect. • The TAPE2 MONITOR mode is ON. 	<ul style="list-style-type: none"> • Make sure the digital connections and the DIGITAL INPUT SELECT is done correctly. • Press the TAPE2 MONITOR button so it goes into the OFF setting.
When using THX AUTO mode the receiver is not playing in the EX mode.	<ul style="list-style-type: none"> • You are not using a source with Surround EX flag. 	<ul style="list-style-type: none"> • There is no problem with your receiver but if you want to hear 7 channel sound use an EX source.
The Dolby Digital / DTS indicator doesn't light up even when playing a Dolby Digital / DTS source.	<ul style="list-style-type: none"> • The player is paused or stopped. • There is a mistake in the player settings for audio output. • Although it's a Dolby Digital / DTS source there is a possibility the present track is not Dolby Digital / DTS. 	<ul style="list-style-type: none"> • Play the source. • Fix the audio settings (check the manual that came with your DVD player). • There is no problem. The indicator won't light when the track is not a Dolby Digital / DTS track.

If the unit does not operate normally due to external effects such as static electricity

Disconnect the power plug from the outlet and insert again to return to normal operating conditions.

Power cord CAUTION!

Handle the power cord by the plug. Do not pull out the plug by tugging the cord and never touch the power cord when your hands are wet as this could cause a short circuit or electric shock. Do not place the unit, a piece of furniture, etc., on the power cord, or pinch the cord. Never make a knot in the cord or tie it with other cords. The power cords should be routed such that they are not likely to be stepped on. A damaged power cord can cause a fire or give you an electrical shock. Check the power cord once in a while. When you find it damaged, ask your nearest PIONEER authorized service center or your dealer for a replacement.



Dear Customer:

Selecting fine audio equipment such as the unit you've just purchased is only the start of your musical enjoyment. Now it's time to consider how you can maximize the fun and excitement your equipment offers. This manufacturer and the Electronic Industries Association's Consumer Electronics Group want you to get the most out of your equipment by playing it at a safe level. One that lets the sound come through loud and clear without annoying blaring or distortion-and, most importantly, without affecting your sensitive hearing.

Sound can be deceiving. Over time your hearing "comfort level" adapts to higher volumes of sound. So what sounds "normal" can actually be loud and harmful to your hearing. Guard against this by setting your equipment at a safe level BEFORE your hearing adapts.

To establish a safe level:

- Start your volume control at a low setting.
- Slowly increase the sound until you can hear it comfortably and clearly, and without distortion.

Once you have established a comfortable sound level:

- Set the dial and leave it there.

Taking a minute to do this now will help to prevent hearing damage or loss in the future. After all, we want you listening for a lifetime.

We Want You Listening For A Lifetime

Used wisely, your new sound equipment will provide a lifetime of fun and enjoyment. Since hearing damage from loud noise is often undetectable until it is too late, this manufacturer and the Electronic Industries Association's Consumer Electronics Group recommend you avoid prolonged exposure to excessive noise. This list of sound levels is included for your protection.

Decibel

Level	Example
30	Quiet library, soft whispers
40	Living room, refrigerator, bedroom away from traffic
50	Light traffic, normal conversation, quiet office
60	Air conditioner at 20 feet, sewing machine
70	Vacuum cleaner, hair dryer, noisy restaurant
80	Average city traffic, garbage disposals, alarm clock at two feet.

THE FOLLOWING NOISES CAN BE DANGEROUS UNDER CONSTANT EXPOSURE

90	Subway, motorcycle, truck traffic, lawn mower
100	Garbage truck, chain saw, pneumatic drill
120	Rock band concert in front of speakers, thunderclap
140	Gunshot blast, jet plane
180	Rocket launching pad

Information courtesy of the Deafness Research Foundation.



Specifications

Amplifier Section

Continuous average power output of 120 watts* per channel, min., at 6 ohms, from 20 Hz to 20,000 Hz with no more than 0.09 % total harmonic distortion (front).**

Continuous Power Output
 Front 120 W + 120 W (20 Hz-20 kHz, 0.09 %, 6 Ω)
 Center 120 W (20 Hz-20 kHz, 0.09 %, 6 Ω)
 Rear 120 W + 120 W (20 Hz-20 kHz, 0.09 %, 6 Ω)

Audio Section

Input (Sensitivity/Impedance)
 PHONO MM 4.7 mV/47 kΩ
 VCR 1/DVR, VCR 2, DVD/LD, TV/SAT, VIDEO, CD
 MD/TAPE 1/CD-R, TAPE 2 335 mV/47 kΩ

Phono Overload level (T.H.D.0.1 %, 1kHz)
 PHONO MM 120 mV

Frequency Response
 PHONO MM 20 Hz to 20,000 Hz ± 0.3 dB
 VCR 1/DVR, VCR 2, DVD/LD, TV/SAT, VIDEO, CD
 MD/TAPE 1/CD-R, TAPE 2 5 Hz to 100,000 Hz ⁺⁰/₋₃ dB

Output (Level/Impedance)
 VCR 1/DVR REC, VCR 2 REC, MD/TAPE 1/CD-R REC
 TAPE 2 REC 335 mV/2.2 kΩ

Tone Control
 BASS ± 6 dB (100 Hz)
 TREBLE ± 6 dB (10 kHz)
 LOUDNESS +10 dB (100 Hz/10 kHz)

Signal-to-Noise Ratio (IHF, short circuited, A network)
 PHONO MM 80 dB
 VCR 1/DVR, VCR 2, DVD/LD, TV/SAT, VIDEO, CD
 MD/TAPE 1, TAPE 2 103 dB
 MULTI CHANNEL IN 103 dB(Channel Level:Bypass)

Signal-to-Noise Ratio [EIA, at 1 W (1 kHz)]
 PHONO MM 80 dB
 VCR 1/DVR, VCR 2, DVD/LD, TV/SAT, VIDEO, CD
 MD/TAPE 1/CD-R, TAPE 2 83 dB

* Measured pursuant to the Federal Trade Commission's Trade Regulation rule on Power Output Claims for Amplifiers.

** Measured by Audio Spectrum Analyzer.

Maintenance of External Surfaces

- Use a polishing cloth or dry cloth to wipe off dust and dirt.
- When the surfaces are dirty, wipe with a soft cloth dipped in some neutral cleanser diluted five or six times with water, and wrung out well, and then wipe again with a dry cloth. Do not use furniture wax or cleaners.
- Never use thinners, benzene, insecticide sprays or other chemicals on or near this unit, since these will corrode the surfaces.

Video Section

Input (Sensitivity) 1 Vp-p/75 Ω
 Output (Level/Impedance) 1 Vp-p/75 Ω
 Signal-to-Noise Ratio 65 dB
 Frequency Response 5 Hz to 10 MHz ⁺⁰/₋₃ dB

Component Video Section

Input (Sensitivity) 1 Vp-p/75 Ω
 Output (Level/Impedance) 1 Vp-p/75 Ω
 Signal-to-Noise Ratio 65 dB

FM Tuner Section

Frequency Range 87.5 MHz to 108 MHz
 Usable Sensitivity Mono: 13.2 dBf, IHF (1.3 μV/75 Ω)
 50 dB Quieting Sensitivity Mono: 20.2 dBf
 Stereo: 38.6 dBf
 Signal-to-Noise Ratio Mono: 73 dB (at 85 dBf)
 Stereo: 70 dB (at 85 dBf)
 Distortion Stereo: 0.5 % (1 kHz)
 Alternate Channel Selectivity 60 dB (400 kHz)
 Stereo Separation 40 dB (1 kHz)
 Frequency Response 30 Hz to 15 kHz (± 1) dB
 Antenna Input 75 Ω unbalanced

AM Tuner Section

Frequency Range 530 kHz to 1,700 kHz
 Sensitivity (IHF, Loop antenna) 350 μV/m
 Selectivity 25 dB
 Signal-to-Noise Ratio 50 dB
 Antenna Loop antenna

Miscellaneous

Power Requirements AC 120 V, 60 Hz
 Power Consumption 460 W, 630 VA
 Power Consumption in Standby mode 1.0 W
 AC Outlet
 SWITCHED (x2) Total 100 W (0.8 A) MAX
 UNSWITCHED 100 W (0.8 A) MAX
 Dimensions 457 (W) × 174 (H) × 470 (D) mm
 (17-15/16 (W) × 6-13/16 (H) × 18-1/2 (D) in.)
 Weight (without package) 17.2 kg (37 lb 15 oz)

Furnished Parts

FM wire Antenna 1
 AM Loop Antenna 1
 "AA" IEC LR6 batteries 4
 Remote Control Unit 1
 Touch Pen 1
 Cushion for Remote 4
 Operating Instructions 1

NOTE:

Specifications and the design are subject to possible modifications without notice, due to improvements.

Should this product require service in the U.S.A. and you wish to locate the nearest Pioneer Authorized Independent Service Company, or if you wish to purchase replacement parts, operating instructions, service manuals, or accessories, please call the number shown below.

8 0 0 – 4 2 1 – 1 4 0 4

Please do not ship your product to Pioneer without first calling the Customer Service Department at the above listed number for assistance.

PIONEER ELECTRONICS SERVICE, INC.
CUSTOMER SERVICE DEPARTMENT
P.O. BOX 1760, LONG BEACH,
CA 90801-1760, U.S.A.

For warranty information please see the Limited Warranty sheet included with your product.

Should this product require service in Canada, please contact a Pioneer Canadian Authorized Dealer to locate the nearest Pioneer Authorized Service Company in Canada. Alternatively, please contact the Customer Service Department at the following address:

Pioneer Electronics of Canada, Inc.
Customer Service Department
300 Allstate Parkway, Markham, Ontario L3R
OP2
(905) 479-4411
1-877-283-5901

For warranty information please see the Limited Warranty sheet included with your product.

Si ce produit doit être réparé au Canada, veuillez vous adresser à un distributeur autorisée Pioneer au Canada pour obtenir le nom de la Société de Service Autorisée Pioneer le plus près de chez vous. Ou encore, veuillez vous communiquer avec le Service de Clientèle de Pioneer:

Pioneer électroniques du Canada, Inc.
Département de service au consommateurs
300 Allstate Parkway, Markham, Ontario L3R
OP2
(905) 479-4411
1-877-283-5901

Pour obtenir des renseignements sur la garantie, veuillez vous reporter au feuillet sur la Garantie Limitée qui accompagne le produit.

Published by Pioneer Corporation.
Copyright © 2000 Pioneer Corporation.
All rights reserved.

PIONEER CORPORATION 4-1, Meguro 1-Chome, Meguro-ku, Tokyo 153-8654, Japan
PIONEER ELECTRONICS [USA] INC. P.O. BOX 1540, Long Beach, California 90801-1540, U.S.A.
PIONEER ELECTRONICS OF CANADA, INC. 300 Allstate Parkway, Markham, Ontario L3R OP2, Canada
PIONEER EUROPE NV Haven 1087, Keetberglaan 1, B-9120 Melsele, Belgium TEL: 03/570.05.11
PIONEER ELECTRONICS AUSTRALIA PTY. LTD. 178-184 Boundary Road, Braeside, Victoria 3195, Australia, TEL: [03] 9586-6300
PIONEER ELECTRONICS DE MEXICO S.A. DE C.V. San Lorenzo 1009 3er Piso Desp. 302 Col. Del Valle Mexico D.F. C.P. 03100
TEL: 5-688-52-90